

UNILUX

AXIO & ELITE

AXIO + ELITE

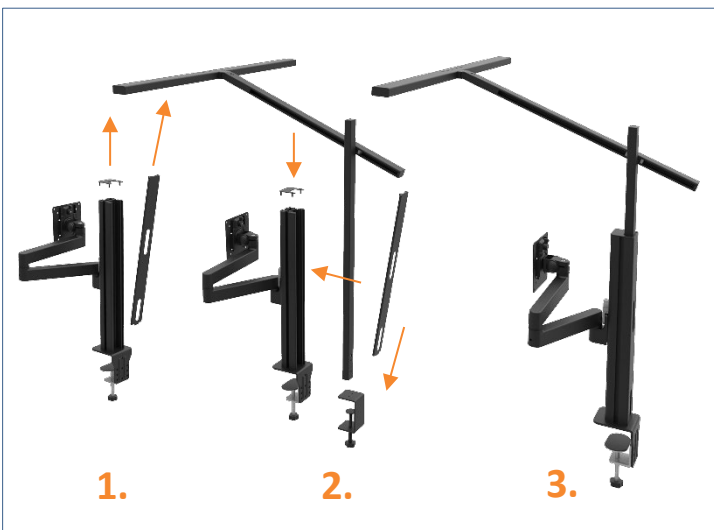

Discover an innovative concept combining ergonomics and well-being with the AXIO monitor arm and the ELITE lamp. Featuring a sliding arm and multiple functions, ELITE provides optimal lighting. Its light therapy mode promotes vitality and comfort throughout the day, with quick and easy installation on the AXIO arm.

AXIO & ELITE

- **Innovative** : discover a groundbreaking concept that combines lighting and ergonomics. The ELITE lamp integrates effortlessly with the AXIO dual monitor arm for quick and seamless installation.
- **Ergonomic** : easily adjust the height, tilt, and depth of your screen to adopt an optimal posture and improve visual comfort.
- **Increased productivity** : the AXIO monitor arm, paired with the ELITE lamp, creates a well-organized and ergonomic workspace that fosters focus and enhances daily efficiency.
- **Optimized lighting** : adjustable and versatile, ELITE provides tailored, adaptable lighting to suit your activities.
- **Light therapy mode** : ELITE features a light therapy mode that promotes well-being and vitality throughout the day, helping to reduce symptoms of depression, including seasonal affective disorder caused by lack of light.
- **Space-saving** : free up desk space by elevating your monitors, creating a cleaner and more functional workstation.

Features AXIO

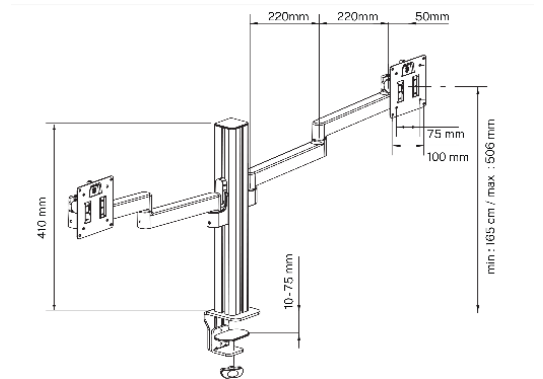
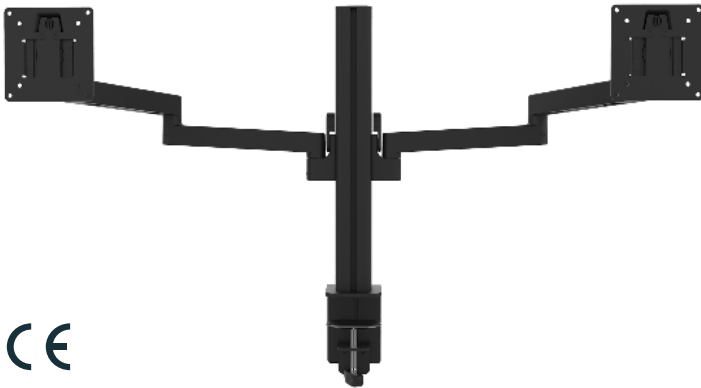

Materials : steel and recyclable aluminum.

Warranty : 2 years.

| | |
|--------------------|---------------------|
| SAP. code | 400207202 |
| EAN code | 3595560043637 |
| Height range (mm) | 165 to 506 |
| Screen size | 13" - 36" |
| Load capacity (kg) | 2 x 10 |
| VESA (mm) | 75 x 75 & 100 x 100 |
| Tilt | +50° to -45° |
| Swivel | +90° ~ -90° |
| Rotation | +180° ~ -180° |
| Installation | Clamp |
| Net weight (kg) | 4.2 |

Features ELITE

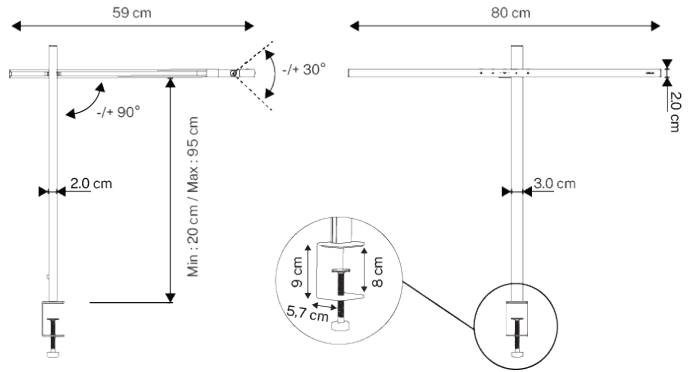

Materials : recyclable aluminum head and arm.

Warranty : 2 years

Measurement in lux on the work surface from a top view at 40 cm :

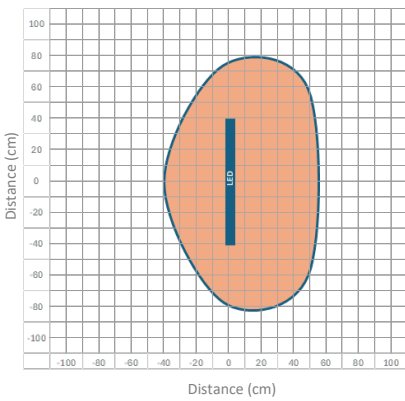

> 500 Lux

Measurement in lux on the work surface from a side view at 40 cm :

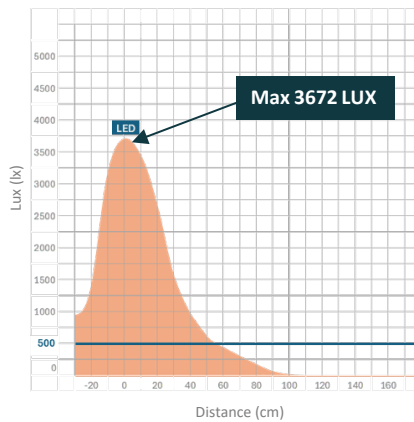

Measurement in nanometers of the light spectrum :

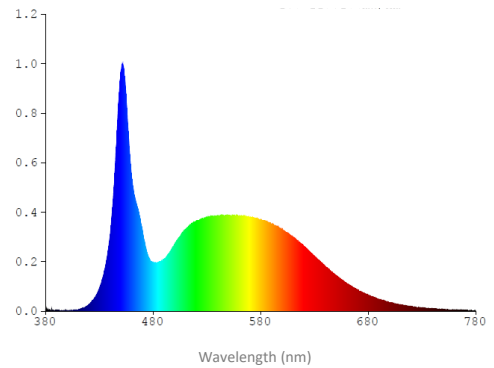

- 0 No-risk
- 1 Low-risk
- 2 Moderate-risk
- 3 High-risk

| | |
|------------------------------|---------------------------|
| SAP. code | 400207202 |
| EAN code | 3595560043637 |
| Color | Black |
| Luminous flux (lm) | 2993 |
| Lux (Lx) | 3672 at 40 cm |
| Melanopic lux (lx)* | 2599 at 30 cm |
| Energy efficiency (lm/W) | 121 |
| Color temperature (K) | 3000 / 4000 / 5000 / 6500 |
| CRI | 84 |
| Source lifespan (h) | 50 000 |
| Energy consumed (kWh/1000 h) | 24 |
| Net weight (kg) | 1.7 |

*Melanopic lux is a measure of light weighted according to its ability to stimulate retinal cells involved in regulating the circadian rhythm. A melanopic light level of 250 to 300 lux is sufficient to trigger a beneficial biological response, promoting alertness, circadian rhythm regulation, and reduced sleepiness.

ABOUT

UNILUX

Founded in 1952, UNILUX is a French company specializing in lighting and ergonomics. Over the past 25 years, UNILUX has become a benchmark in the field of lighting in France and throughout Europe. In 2000, UNILUX joined the French group HAMELIN, a European leader in stationery. The company modernizes and evolves to become a creator of ambiance and well-being.



OUR EXPERTISE

When Unilux combines design, lighting, and ergonomics, efficiency meets well-being.

Unilux is reinventing the workspace with an innovative concept: the combination of ergonomics and our lighting expertise. The result? Exceptional products with refined design and innovative features.

The monitor arm optimizes space while improving posture. It frees up the desk, encourages natural positioning, and reduces eye strain, neck and back tension—ensuring lasting comfort and increased productivity.

A true signature product, the ELITE desk lamp reflects our lighting expertise and integrates multiple features to provide optimal lighting comfort throughout the day.

Add to that the benefits of light therapy: a daily boost to enhance your motivation, well-being, and performance.

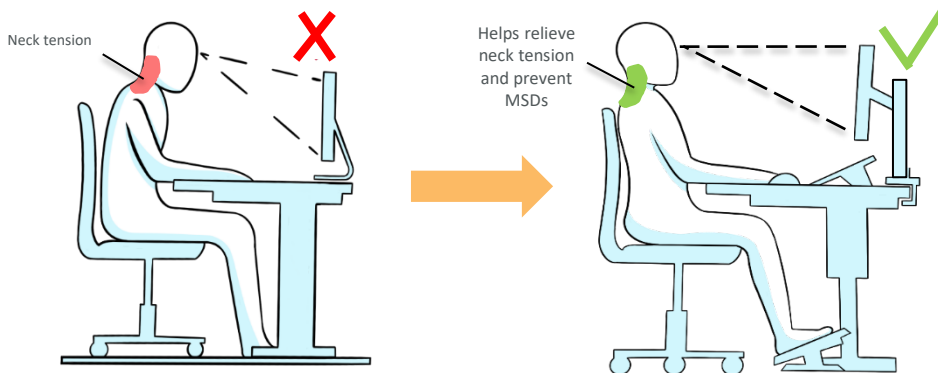

OUR CSR COMMITMENTS



Unilux focuses on sustainable development and takes concrete measures to reduce its environmental footprint and best meet the evolving expectations of its consumers.



We are notably committed to reduce our greenhouse gas emissions by 29% between 2021 and 2030 in response to the "Net Zero Carbon Emissions by 2050" challenge. Eco-design, emissions reduction, and continuous improvement are at the core of our concerns.

pCon Planner

Integrate Unilux products seamlessly into your 3D space designs.
Access to essential data : dimensions, prices, etc.



Website







Explore our full range, tips, blog articles, and more.



Do you have any questions ?

Our customer service is always available to assist you.

GLOSSARY

-  ON / OFF
-  Light intensity dimming
-  Color temperature variation
-  Asymmetrical lighting
-  Replaceable light source (LED only) by a professional.
-  European compliance
-  Energy class