

35314

ShredMATIC®

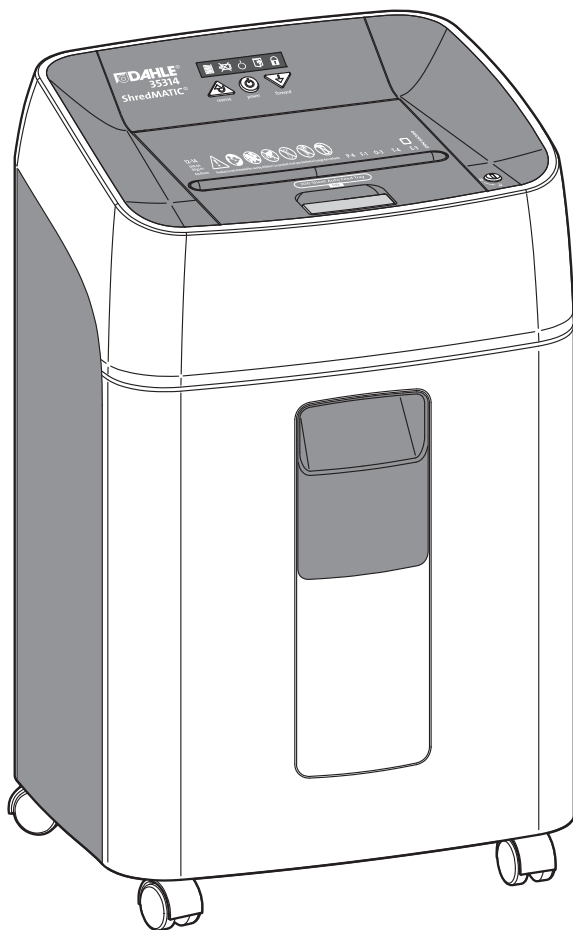

CE



DAHLE®



de	Originalgebrauchsanleitung	4
en	Instructions	7
fr	Mode d'emploi	10
es	Instrucciones	13
it	Istruzioni per l'uso	16
pt	Manual de instruções	19
nl	Gebruikershandleiding	22
da	Betjeningsvejledning	25
fi	Käyttöohje	28
no	Bruksanvisning	31
sv	Bruksanvisning	34
sl	Navodilo za uporabo	37
hr	Upute za uporabu	40
hu	Használati utasítás	43
ru	Инструкция по применению	46
et	Juhised	49
lt	Naudojimo instrukcija	52
lv	Lietošanas norādījumi	55
cs	Návod k použití	58
sk	Návod na použitie	61
pl	Instrukcja użytkowania	64
ro	Instrucțiuni de utilizare	67
bg	Указание за употреба	70
tr	Kullanım kılavuzu	73
el	Οδηγίες χρήσης	76
ar	تعليمات	79
ja	取扱説明書	82
zh	使用说明	85



de Originalgebrauchsanleitung



ACHTUNG!

Lesen Sie VOR Inbetriebnahme des Aktenvernichters die Gebrauchsanleitung und Sicherheitshinweise aufmerksam durch. Die Hinweise müssen angewendet werden! Bewahren Sie die Gebrauchsanleitung für den späteren Gebrauch auf.



Inhaltsverzeichnis

1 Wichtige Informationen 4

1.1 Bestimmungsgemäße Verwendung, Gewährleistung 4

1.2 Sicherheitshinweise 5

1.3 Piktogrammlegende 6

1.4 Lieferumfang 88

1.5 Technische Daten 88

2 Bedienung 89

2.2 Gerät an das Stromnetz anschließen 89

2.3 Gerät einschalten 89

2.4 Papiervernichtung 90

2.10 Dauervorlauf 92

2.11 Verriegelung 93

2.14 CD/DVD-, Kartenvernichtung 94

3 Wartung / Störungsbeseitigung 96

3.1 Schnittgut entleeren 96

3.3 Behälter/Deckel offen 96

3.4 Überhitzung 97

3.5 Papierstau manueller Einzug 97

3.7 Papierstau automatischer Einzug 98

3.10 Papierstau verriegelter automatischer Einzug 99

3.13 Notentriegelung ohne Schlüssel. 100

3.17 Gerät reinigen. 101

1.1 Bestimmungsgemäße Verwendung, Gewährleistung

Der Aktenvernichter ist zum Vernichten von Papier bestimmt.

Je nach Modellvariante kann außerdem eine geringe Menge folgender Materialien vernichtet werden:

- CDs/DVDs, Scheck- und Kreditkarten (siehe Technische Daten).
- die in Papierdokumenten, in anwendungsüblichem Umfang, vorhandenen Heft- und Büroklammern (Ausnahme: Geräte der Sicherheitsstufe P6 und P7).

Das Gerät verfügt über einen automatischen Einzug für Blattstapel, die aus nicht gefalteten Einzelblättern (max. 100g/m²) bestehen. Geklammertes Papier, sowohl mit Büro-, als auch mit Heftklammern, kann im Regelfall mit verarbeitet werden. Voraussetzung hierfür ist die Anordnung der Klammern an der hinteren Seite des Papierfachs (dem Anwender abgewandt). Um die Lebensdauer des Gerätes zu verlängern, wird jedoch empfohlen, Büro-/Heftklammern vor dem Vernichten zu entfernen. In Einzelfällen, abhängig von Menge und Position der Klammern sowie dem Umfang des geklammerten Blattstapels kann es zum Fehleinzug und damit zur Unterbrechung des Vernichtungsvorgangs kommen.

Verschleiß, Schäden durch unsachgemäßen Gebrauch, sowie Eingriffe von dritter Stelle, fallen weder unter die Gewährleistung noch unter die Garantie

Der Aktenvernichter ist für den Betrieb im privaten Bereich und normaler Büroumgebung konzipiert. Bzgl. der unter technische Daten angegebenen Blattleistung gelten folgende Rahmenbedingungen: Maximale Anzahl von Blättern, die in einem Durchgang unter folgenden Bedingungen geschnitten werden: Neue ggfs. geölte Schneidwalzen, kalter Motor,

1.2 Sicherheitshinweise

Stromversorgung mit Nennspannung und Nennfrequenz (230V/50Hz; 120V/60Hz). Abweichungen können zu einer geringeren Blattleistung und zu erhöhten Laufgeräuschen führen.

















Die Blätter werden mittig und längs unter 90° zugeführt. Je nach Papiereigenschaften und Zuführung kann die Blattleistung ebenfalls variieren.







- Das Gerät nicht in der Nähe einer Wärmequelle aufstellen!
- Das Gerät nur stehend lagern, transportieren und betreiben!
- Am Gerät nur Flüssigkeiten und Gase verwenden, welche den DAHLE-Richtlinien entsprechen!
- Das Gerät darf nicht geöffnet werden!
- Das Gerät nur in geschlossenen Räumen, bei 10°C bis 25°C (50°F bis 77°F) und einer nichtkondensierenden Luftfeuchtigkeit von 15% bis 95% betreiben!
- Die Kurzschlussicherheit der Gebäudeinstallation ist sicherzustellen: max. 16A (US max. 20A).
- Das Gerät nicht im Leerlauf betreiben!
- Das Gerät ist nicht zur Benutzung von Personen bestimmt (einschließlich Kinder) mit eingeschränkten physischen, sensorischen oder geistigen Fähigkeiten oder mangelnder Erfahrung und Wissen, es sei denn, sie arbeiten unter Aufsicht oder erhalten eine ausführliche Anleitung zur Benutzung des Gerätes von einer Person die für die Sicherheit verantwortlich ist.



Entsorgen Sie den Aktenvernichter fach- und umweltgerecht bei einer autorisierten Sammelstelle. Geben Sie keine Teile des Aktenvernichters oder der Verpackung in den Hausmüll.

1.3 Piktogrammlegende

-  Wichtige Information
-  Gebrauchsanleitung/
Sicherheitshinweise lesen.
-  ACHTUNG
-  Nicht in der Nähe von ätzenden Stoffen
verwenden.
-  Das Gerät standsicher auf dem Boden und
mit 100 mm Abstand zur Wand aufstellen,
Stauwärme vermeiden, Feststellbremsen
betätigen (Typenabhängig).
-  Nicht in der Nähe von brennbaren
Flüssigkeiten oder Gasen verwenden.
-  Automatischer Anlauf
-  Nicht der Nässe aussetzen
-  Dieser Aktenvernichter ist nicht zur
Benutzung durch Kinder bestimmt (das
Produkt ist kein Spielzeug).
-  Berühren Sie die Papierzuführung nicht
mit den Händen.
-  Berühren Sie die Papierzuführung nicht
mit Kleidungsstücken!
-  Berühren Sie die Papierzuführung nicht
mit den Haaren!
-  Halten Sie Spraydosen fern!
-  Büro- und Heftklammern vor dem
Vernichtungsvorgang entfernen!
-  Keine Disketten einführen!
-  Beim Vernichten von CD/DVD ist eine
Schutzbrille zu tragen!
-  Vor Wartungsarbeiten den Aktenvernichter
von der Stromversorgung trennen!

-  Technische Daten -
Technische Änderungen vorbehalten!
-  Betriebslautstärke im Leerlauf
-  Einzugs geschwindigkeit
-  Papier-Partikelschnitt
-  CD/DVD-Partikelschnitt
-  Karten-Partikelschnitt
-  Gewicht
-  Netzstecker dient als Trennvorrichtung der
Stromversorgung.
-  Die Steckdose soll in der Nähe vom Gerät
angbracht und leicht zugänglich sein!
-  Bedienung
-  Aktenvernichter in Bereitschaft
-  Aktenvernichter in Betrieb
-  Automatische Abschaltung!
-  Bei längerem Betrieb und/oder
Überlastung schaltet der Aktenvernichter
automatisch zum Abkühlen ab.
-  Wartungshinweise / Störungsbeseitigung
-  Behälter voll
-  Mögliche Störungen
-  automatische Abschaltung bei offenem
Gehäuse

en Instructions



IMPORTANT!

Read the operating and safety instructions BEFORE placing the document shredder into operation.

You must follow the instructions.

Keep the operating instructions in a safe place ready for later use.

Table of Contents

1	Important information	7
1.1	Intended use, warranty	7
1.2	Safety instructions.	8
1.3	Key to pictograms	9
1.4	Scope of supply.	88
1.5	Technical data	88
2	Operation	89
2.2	Connecting the device to the power supply .	89
2.3	Switching on the device	89
2.4	Paper shredding	90
2.10	Continuous operation	92
2.11	Locking	93
2.14	CD, DVD & card shredding.	94
3	Maintenance/troubleshooting	96
3.1	Empty shredded waste	96
3.3	Container/cover open.	96
3.4	Overheating	97
3.5	Paper jam, manual intake	97
3.7	Paper jam, automatic intake	98
3.10	Paper jam, locked automatic intake	99
3.13	Emergency unlocking without a key	100
3.17	Cleaning the device	101

1.1 Intended use, warranty

The document shredder is intended to be used for shredding paper.

Depending on the model variant, a small amount of the following materials can also be shredded:

- CDs/DVDs, bank cards and credit cards (see technical data).
- The normal staples and paper clips found in paper documents (exception: security level P6 and P7 devices).

The device has an automatic intake for paper stacks that consist of individual sheets that are not folded (max. 100 g/m²). Paper clipped together, either with paper clips or staples, can generally also be processed in the stacks. The precondition for this that the clips should be on the rear side of the paper tray (pointing away from the user). However, removing the office clips/staples before shredding is recommended to extend the life of the device. In individual cases, depending on the quantity and position of the clips and the thickness of the clipped stack, misfeeding and hence an interruption of the shredding process may occur.

Wear, damage due to improper use or unauthorised modifications and repairs are not covered by the warranty or the guarantee.

The document shredder was designed for private use and for use in normal office environments.

The following conditions apply to the sheet capacity specified under technical data:

Maximum number of sheets that are shredded in one pass under the following conditions: New shredding rollers, oiled if needed, cold motor, power supply with rated voltage and rated frequency (230 V/50 Hz; 120 V/60 Hz).



Deviations may result in a lower sheet capacity and increased operating noise.

The sheets are fed centrally and lengthwise at an angle of 90 degrees. The sheet capacity may also vary depending on the sheet characteristics and how they are fed in.

1.2 Safety instructions

- Do not place the device near a source of heat.
- Store, transport and operate the device in an upright position only.
- Only use liquids and gases on the device that comply with DAHLE guidelines.
- Do not open up the device.
- Only operate the device in closed spaces, at temperatures of between 10 °C and 25 °C (50 °F to 77 °F) and at a non-condensing humidity of between 15% and 95%.
- Ensure that the building installation has short-circuit protection: max. 16 A (US max. 20 A).
- Do not operate the document shredder without inserting documents.
- The device is not intended for use by persons (including children) with restricted physical, sensory or mental capabilities or a lack of experience and knowledge, unless they are working under supervision or receive detailed instruction about how to use the device from a person who is responsible for safety.



Dispose of the document shredder properly in an environmentally friendly way at an authorised collection point. Do not dispose of any parts of the document shredder or packaging in domestic waste.



1.3 Key to pictograms



Important information



User information/safety instructions



WARNING



Do not use near caustic substances.



Place the device in a stable position on the floor, leaving a gap of 100 mm to the wall, ensure no heat can accumulate, engage brake mechanisms (depending on type)



Do not use near inflammable liquids or gases.



Automatic start-up



Do not expose to moisture



This document shredder is not intended to be used by children (the product is not a toy).



Do not touch the paper feed with your hands.



Do not allow items of clothing to come into contact with the paper feed.



Do not allow your hair to come into contact with the paper feed.



Keep spray cans away from the device.



Remove paper clips and staples before shredding.



Do not insert any diskettes.



Always wear safety goggles when destroying CDs/DVDs!



Disconnect the document shredder from the electrical power supply before performing maintenance work.



Technical specifications - Subject to technical modifications.



Noise level when operated without shredding documents



Intake speed



Shredded paper particles



Shredded CD/DVD particles



Shredded card particles



Weight



The power plug is used to disconnect the power supply.



The power outlet must be located in the vicinity of the device and easily accessible.



How to use



Document shredder on standby



Document shredder in operation



Automatic shut-down!



The document shredder will switch off automatically to cool down if used for a long time and /or if overloaded



Maintenance instructions / troubleshooting



Container full



Possible malfunctions



Automatic switch-off when housing is open

**ATTENTION !**

Lisez attentivement le mode d'emploi et les consignes de sécurité AVANT de mettre en marche le destructeur de documents ! Les consignes doivent être appliquées !

Conservez le mode d'emploi pour une utilisation ultérieure.

**Sommaire**

1	Informations importantes	10
1.1	Utilisation conforme, garantie	10
1.2	Consignes de sécurité	11
1.3	Légende des pictogrammes	12
1.4	Contenu de la livraison	88
1.5	Caractéristiques techniques	88
2	Utilisation	89
2.2	Connecter l'appareil au réseau électrique	89
2.3	Allumer l'appareil	89
2.4	Destruction de documents	90
2.10	Avance continue	92
2.11	Verrouillage	93
2.14	Destruction de CD/DVD et de cartes	94
3	Entretien/dépannage	96
3.1	Vider le matériau découpé	96
3.3	Bac/couvercle ouvert	96
3.4	Surchauffe	97
3.5	Bourrage de papier introduction manuelle	97
3.7	Bourrage de papier introduction automatique	98
3.10	Bourrage de papier introduction automatique verrouillée	99
3.13	Déverrouillage d'urgence sans clé	100
3.17	Nettoyer l'appareil	101

1.1 Utilisation conforme, garantie

Le destructeur de documents est destiné à détruire des documents papier.

Selon le modèle, vous pouvez en outre utiliser l'appareil pour détruire les matériaux suivants en petite quantité :

- CD/DVD, cartes bancaires et de crédit (voir Caractéristiques techniques).
- Les agrafes et trombones présents dans les documents en papier, en quantités représentant une utilisation normale (exception : appareils de niveau de sécurité P6 et P7).

L'appareil est équipé d'une introduction automatique pour les piles de feuilles composées de feuilles individuelles non pliées (max. 100g/m²). Le papier agrafé, que ce soit grâce à des trombones ou des agrafes, peut, en règle générale, également être traité. Pour ce faire, il est indispensable de disposer les agrafes à l'arrière du bac à papier (à l'opposé de l'utilisateur). Toutefois, pour prolonger la durée de vie de l'appareil, il est recommandé de retirer les agrafes/trombones avant la destruction. Dans certains cas, en fonction de la quantité et de la position des agrafes ainsi que du volume de la pile de feuilles agrafées, une introduction incorrecte peut survenir et le processus de destruction peut ainsi être interrompu.

L'usure, les dommages dus à une utilisation incorrecte et les interventions de tierces personnes ne sont pas couvertes par la responsabilité du fabricant ni par la garantie

Le destructeur de documents est conçu pour l'utilisation domestique et en environnement de bureau normal.

En ce qui concerne la capacité de feuilles mentionnée dans les caractéristiques techniques, les conditions cadres suivantes sont applicables :

Nombre maximum de feuilles pouvant être découpées en un passage dans les conditions suivantes : Rouleaux de coupe neufs, huilés le cas échéant, moteur froid, alimentation électrique avec tension et fréquence nominales (230 V/50 Hz ; 120 V/60 Hz).



1.2 Consignes de sécurité

Des divergences peuvent entraîner une capacité de feuilles réduite et des émissions sonores accrues.

Les feuilles sont introduites au centre et en longueur à un angle inférieur à 90°. La capacité de feuilles peut également varier selon les caractéristiques du papier et l'introduction.

- Ne pas installer l'appareil à proximité d'une source de chaleur !
- Ranger, transporter ou utiliser l'appareil en position verticale uniquement !
- Utiliser à proximité de l'appareil uniquement des liquides et des gaz conformes aux directives DAHLE !
- Il est interdit d'ouvrir l'appareil !
- Utiliser l'appareil dans des locaux fermés uniquement, à des températures comprises entre 10 °C et 25 °C (entre 50 °F et 77 °F) et une hygrométrie non condensée comprise entre 15 % et 95 % !
- L'installation électrique du bâtiment doit être protégée contre les courts-circuits 16 A max. (20 A max. aux USA).
- Ne pas laisser l'appareil tourner à vide !
- L'appareil n'est pas destiné à une utilisation par des personnes (y compris les enfants) aux capacités physiques, sensorielles ou mentales diminuées ou ne disposant pas de l'expérience et du savoir nécessaire, à moins que celles-ci soient sous surveillance ou qu'elles reçoivent des consignes exhaustives concernant l'utilisation de l'appareil de la part d'une personne responsable de la sécurité.



Éliminez le destructeur de documents dans le respect des règles et de l'environnement dans un point de collecte autorisé. Ne jetez pas de composants du destructeur de documents ou de l'emballage dans les ordures ménagères.



1.3 Légende des pictogrammes



Information importante



Lire les informations pour l'utilisateur/
consignes de sécurité



ATTENTION



Ne pas utiliser l'appareil à proximité de
substances corrosives.



Placer l'appareil au sol de manière à ce
qu'il soit bien stable et à une distance
de 100 mm du mur, éviter la chaleur sta-
gnante, actionner les freins de blocage
(selon le modèle)



Ne pas utiliser l'appareil à proximité de
liquides ou de gaz inflammables.



Démarrage automatique



Ne pas exposer l'appareil à l'humidité.



Ce destructeur de documents n'est pas
destiné à être utilisé par des enfants (le
produit n'est pas un jouet).



Ne touchez pas le dispositif d'alimentation
du papier avec les mains.



Ne touchez pas le dispositif d'alimentation
du papier avec vos vêtements !



Ne touchez pas le dispositif d'alimentation
du papier avec vos cheveux !



Tenez les bombes aérosols à l'écart !



Retirer les trombones et les agrafes des
documents avant de les détruire !



Ne pas introduire de disquettes !



Lors de la destruction de CD/DVD, le port
de lunettes de protection est obligatoire !



Débrancher le destructeur de documents
de l'alimentation électrique avant de pro-
céder aux opérations d'entretien !



Caractéristiques techniques - Sous réserve
de modifications techniques !



Volume sonore à vide



Vitesse d'introduction



Coupe en particules de papier



Coupe en particules de CD/DVD



Coupe en particules de cartes



Poids



La prise sert de dispositif de sectionne-
ment de l'alimentation électrique.



La prise de courant doit se situer à proxi-
mité de l'appareil et être facilement acces-
sible !



Utilisation



Destructeur de documents en veille



Destructeur de documents en marche



Arrêt automatique !



Le destructeur de documents s'éteint
automatiquement après une utilisation
prolongée et/ou en cas de surcharge afin
de refroidir.



Consignes d'entretien/Dépannage



Bac plein



Problèmes possibles



Arrêt automatique en cas de boîtier ouvert

**es Instrucciones****ATENCIÓN:**

Lea detenidamente las instrucciones de uso y las indicaciones sobre seguridad antes de poner en marcha la destructora. Deben cumplirse todas las indicaciones.

Guarde el manual de instrucciones por si lo necesita en otro momento.

**Índice**

1	Información importante	13
1.1	Utilización conforme al uso prescrito, garantía	13
1.2	Indicaciones de seguridad	14
1.3	Significado de los pictogramas	15
1.4	Contenido de suministro.	88
1.5	Datos técnicos	88
2	Manejo.	89
2.2	Conectar el aparato a la red eléctrica.	89
2.3	Encender el aparato.	89
2.4	Destrucción de papel	90
2.10	Ejecución continua	92
2.11	Bloqueo	93
2.14	Destrucción de CD/DVD y tarjetas	94
3	Mantenimiento/Resolución de problemas	96
3.1	Vaciado del contenedor	96
3.3	Contenedor abierto/tapa abierta	96
3.4	Sobrecalentado	97
3.5	Atasco con alimentación de papel manual	97
3.7	Atasco con alimentación de papel automática.	98
3.10	Atasco con alimentación de papel automática bloqueada	99
3.13	Desbloqueo de emergencia sin llave.	100
3.17	Limpieza del aparato	101

1.1 Utilización conforme al uso prescrito, garantía

La destructora está destinada a triturar papel. Según la variante del modelo, se puede triturar además una pequeña cantidad de los siguientes materiales:

- CDs/DVDs, tarjetas bancarias y tarjetas de crédito (véase Datos técnicos).
- Los clips y grapas que lleven los documentos en papel, dentro de los límites del uso habitual (excepción: equipos de nivel de seguridad P6 y P7).

El aparato dispone de un alimentador automático para pilas de hojas sueltas no plegadas (máx. 100 g/m²). Las grapas y clips pueden, por regla general, ser procesadas. Para ello es necesario disponer los clips o grapas en la parte posterior de la bandeja de papel (alejado del usuario). Sin embargo, para prolongar la vida útil del aparato, se recomienda retirar las grapas o clips antes de destruir el papel. En función de la posición de las grapas y de la cantidad de hojas grapadas, en algunos casos se puede producir una alimentación incorrecta e interrumpirse el proceso de destrucción.

La garantía no cubre el desgaste, los daños causados por uso indebido ni las consecuencias de una manipulación por parte de terceros.

La destructora está pensada para ser usada por particulares y en entornos normales de oficina.

Los datos técnicos relativos a la alimentación de papel están sujetos a las siguientes condiciones: Cantidad máxima de hojas cortadas de una vez en las siguientes condiciones: Tambor de corte nuevo y engrasado (si procede), motor en frío, corriente eléctrica con tensión y frecuencia nominal (230 V/50 Hz, 120 V/60 Hz). Las variaciones pueden repercutir en una reducción de la alimentación de papel y en un aumento de los ruidos de funcionamiento.



1.2 Indicaciones de seguridad

Las hojas se deben introducir centradas y a lo largo a 90°. La capacidad de alimentación del papel también puede variar dependiendo de las características del papel y el modo de introducirlo.

- No colocar el aparato cerca de ninguna fuente de calor.
- Almacenar, transportar y utilizar el aparato exclusivamente en posición vertical.
- Aplicar a la destructora exclusivamente líquidos y gases que cumplan las especificaciones de DAHLE.
- No abrir el aparato.
- Utilizar el aparato exclusivamente en lugares cerrados, a una temperatura entre 10 °C y 25 °C (entre 50 °F y 77 °F) y con una humedad ambiental no condensante entre el 15% y el 95%.
- La instalación eléctrica del edificio deberá estar protegida contra cortocircuitos: máx. 16 A (para EE.UU. máx. 20 A).
- El aparato nunca debe funcionar en vacío.
- Este aparato no está destinado a su uso por parte de personas (incluidos niños) con facultades físicas, sensoriales o mentales reducidas o con falta de experiencia y conocimiento, salvo que lo utilicen bajo la supervisión de una persona que se responsabilice de la seguridad o esta les haya instruido de forma detallada en el manejo del aparato.



Desechar la destructora debidamente en un punto limpio autorizado y cumpliendo la normativa medioambiental. No deseche ninguna parte de la destructora ni del embalaje con la basura doméstica.



1.3 Significado de los pictogramas



Información importante



Leer atentamente la información para el usuario y las indicaciones de seguridad



ATENCIÓN



No utilizar cerca de sustancias corrosivas.



Colocar el aparato en el suelo y en posición vertical estable, a una distancia de 100 mm de la pared, evitando que se acumule el calor, accionar los frenos inmovilizadores (en determinados modelos)



No utilizar cerca de líquidos o gases inflamables.



Inicio automático



Evitar que el aparato se moje.



Esta destructora no está destinada para ser utilizada por niños (este producto no es un juguete).



No tocar el alimentador de papel.



Evitar que la ropa entre en contacto con el alimentador de papel.



No aproximar el cabello al alimentador de papel.



No aproximar botes de spray.



Antes de destruir papel, retirar todos los clips y grapas que pueda llevar.



No introducir disquetes.



Cuando se destruyan CD o DVD, deben colocarse gafas protectoras.



Antes de realizar cualquier trabajo de mantenimiento, desconectar la destructora de la red eléctrica.



Datos técnicos - ¡Sujeto a modificaciones técnicas sin previo aviso!



Emisión de ruido durante el funcionamiento



Velocidad de inserción



Corte de papel en partículas



Corte de discos CD/DVD en partículas



Corte de tarjetas en partículas



Peso



La clavija de red actúa como dispositivo desconector de la alimentación eléctrica.



¡El enchufe debe estar situado cerca del aparato y ser fácilmente accesible!



Manejo



Destructora lista para ser utilizada



Destructora en funcionamiento



Desconexión automática.



En caso de sobrecarga o de un uso excesivo, la destructora se apaga automáticamente para enfriarse.



Consejos de mantenimiento y resolución de problemas



Depósito lleno



Posibles averías



El aparato se desconecta automáticamente cuando se abre la carcasa.

**ATTENZIONE!**

PRIMA della messa in funzione della distruggidocumenti, leggere attentamente il manuale d'uso e le istruzioni di sicurezza. Le istruzioni devono essere applicate!

Conservare il manuale d'uso per l'utilizzo successivo.

**Indice**

1	Informazioni importanti	16
1.1	Utilizzo conforme, garanzia.	16
1.2	Istruzioni di sicurezza	17
1.3	Legenda pittogrammi	18
1.4	Oggetto della fornitura.	88
1.5	Dati tecnici	88
2	Uso	89
2.2	Collegare l'apparecchio alla rete della linea elettrica	89
2.3	Accendere l'apparecchio	89
2.4	Distruzione della carta	90
2.10	Avanzamento permanente	92
2.11	Blocco	93
2.14	Distruzione di CD/DVD e carte.	94
3	Manutenzione/Riparazione	96
3.1	Eliminare il materiale triturato	96
3.3	Contenitore/coperchio aperto	96
3.4	Surriscaldamento.	97
3.5	Inceppamento carta caricamento manuale	97
3.7	Inceppamento carta caricamento automatico.	98
3.10	Inceppamento carta caricamento automatico bloccato	99
3.13	Sblocco di emergenza senza chiave	100
3.17	Pulizia dell'apparecchio	101

1.1 Utilizzo conforme, garanzia

Il distruggi documenti è destinato alla distruzione di carta.

A seconda del modello è inoltre possibile distruggere una piccola quantità dei seguenti materiali:

- CD/DVD, carte assegni e carte di credito (vedere dati tecnici).
- Le graffette e i punti metallici comunemente utilizzati per fascicolare i documenti di carta (eccezione: apparecchi di livello di sicurezza P6 e P7).

L'apparecchio è predisposto per il caricamento automatico di pile di fogli non piegati (massimo 100 g/m²). Anche i fogli fissati, sia con graffette che con punti, possono generalmente essere utilizzati. Fondamentale è che la posizione delle graffette sia rivolta verso il lato posteriore del cassetto per la carta (sul lato opposto rispetto all'utente). Per prolungare la durata dell'apparecchio, si consiglia tuttavia di eliminare punti e graffette prima della distruzione. In casi limitati, a seconda della quantità e posizione delle graffette, nonché dello spessore della pila di carta, può verificarsi un inserimento scorretto e, di conseguenza, il processo di distruzione potrebbe essere interrotto.

La garanzia non comprende l'usura, i danni da utilizzo non conforme, nonché gli interventi da parte di terzi.

Il distruggidocumenti è concepito per l'utilizzo privato o per il normale utilizzo nell'ambiente di ufficio.

La portata di fogli riportata nei dati tecnici è soggetta alle seguenti condizioni generali:

Numero massimo di fogli tagliati per volta nelle seguenti condizioni: rulli di taglio nuovi o lubrificati, motore freddo, alimentazione elettrica con tensione nominale e frequenza nominale (230 V/50 Hz; 120 V/60 Hz). Condizioni diverse da quelle indicate possono comportare una portata di fogli inferiore e un aumento del rumore generato dal dispositivo in funzione.

1.2 Istruzioni di sicurezza

I fogli vanno inseriti al centro e per il lungo con un'inclinazione inferiore a 90°. La portata di fogli può variare a seconda delle proprietà della carta e dell'inserimento.

- Non posizionare l'apparecchio in prossimità di fonti di calore!
- Utilizzare, riporre e trasportare l'apparecchio esclusivamente in posizione verticale!
- Sull'apparecchio utilizzare solo sostanze liquide o gassose conformi alle direttive DAHLE!
- Non aprire l'apparecchio!
- È necessario garantire che l'impianto dell'edificio sia protetto da cortocircuiti: max. 16 A (US massimo 20 A).
- Utilizzare l'apparecchio solo in ambienti chiusi, a temperature comprese tra i 10 °C e i 25 °C (da 50 °F a 77 °F) e con un'umidità dell'aria senza condensa tra il 15% e il 95%!
- Non utilizzare l'apparecchio a vuoto!
- L'apparecchio non è adatto all'utilizzo da parte di persone con ridotte capacità fisiche, sensoriali o mentali (inclusi i bambini), oppure prive della necessaria esperienza o conoscenza, a meno che non lavorino sotto sorveglianza o che ricevano istruzioni dettagliate circa l'utilizzo dell'apparecchio da una persona responsabile della sicurezza.



La distruggidocumenti deve essere smaltita in conformità con le norme vigenti in materia di tutela dell'ambiente presso un centro di raccolta autorizzato. Non gettare alcun componente della distruggidocumenti o dell'imballaggio nei rifiuti domestici.



1.3 Leggenda pittogramma



Informazioni importanti



Leggere le informazioni utente e le istruzioni di sicurezza



ATTENZIONE



Non utilizzare in prossimità di sostanze corrosive.



Posizionare l'apparecchio sul pavimento e a una distanza di 100 mm dalla parete, evitare ristagni di calore, azionare i freni di blocco (a seconda del modello)



Non utilizzare in prossimità di liquidi o gas infiammabili.



Avvio automatico



Non esporre all'umidità



L'apparecchio non è destinato all'uso da parte dei bambini (il prodotto non è un giocattolo).



Non toccare l'alimentatore della carta con le mani.



Assicurarsi che gli abiti non tocchino l'alimentatore della carta!



Non toccare l'alimentatore della carta con i capelli!



Tenere lontano da bombolette spray!



Prima di distruggere i documenti, rimuovere punti e graffette!



Non inserire dischetti!



Indossare occhiali di protezione, quando si distruggono CD/DVD.



Prima degli interventi di manutenzione, staccare la presa della distruggidocumenti!



Dati tecnici – Si riserva la facoltà di apportare modifiche tecniche!



Rumorosità in esercizio a vuoto



Velocità di inserimento



Taglio carta a particelle



Taglio CD/DVD a particelle



Taglio carte plastificate a particelle



Peso



La spina funge da separatore dell'alimentazione di corrente.



La presa di corrente deve essere collocata vicino all'apparecchio ed essere facilmente accessibile!



Utilizzo



Distruggidocumenti in standby



Distruggidocumenti in esercizio



Spegnimento automatico!



Dopo un periodo di esercizio prolungato e/o sovraccarico la distruggidocumenti si spegne automaticamente per garantire il raffreddamento.



Istruzioni per la manutenzione/ Risoluzione delle anomalie



Recipiente pieno



Possibili guasti/anomalie



Spegnimento automatico in caso di cassetto aperto

pt Manual de instruções



ATENÇÃO!

ANTES de colocar a trituradora de papel funcionamento, ler cuidadosamente o manual de utilização e as indicações de segurança.

As indicações devem ser respeitadas! Guarde o manual de utilização para uso futuro.

1.1 Utilização correta, garantia

A trituradora de papel destina-se à trituração de papel.

Conforme a variante do modelo podem ser eliminados os seguintes materiais em quantidades reduzidas:

- CDs/DVDs, cartões de crédito e de cheque (ver dados técnicos).
- Clipes e agramos que estejam presentes, em quantidades normais, nos documentos de papel (exceção: aparelhos com nível de segurança P6 e P7).

Índice

1	Informações importantes	19
1.1	Utilização correta, garantia.	19
1.2	Indicações de segurança	20
1.3	Legenda dos pictogramas	21
1.4	Âmbito de fornecimento.	88
1.5	Dados técnicos	88
2	Operação	89
2.2	Ligar o aparelho à rede elétrica.	89
2.3	Ligar o aparelho	89
2.4	Trituração de papel	90
2.10	Pré-funcionamento permanente	92
2.11	Bloqueio	93
2.14	Trituração de CDs/DVDs e cartões	94
3	Manutenção/resolução de problemas	96
3.1	Esvaziar os resíduos de papel	96
3.3	Recipiente/tampa aberta	96
3.4	Sobreaquecimento	97
3.5	Acumulação de papel na introdução manual	97
3.7	Acumulação de papel na introdução automática.	98
3.10	Acumulação de papel na introdução automática bloqueada	99
3.13	Desbloqueio de emergência sem chave	100
3.17	Limpar o aparelho	101

O aparelho dispõe de uma introdução automática para pilhas de papel formadas por folhas individuais não dobradas (máx. 100 g/m²). Por regra, papel unido com clipes ou agramos também pode ser processado. Isto pressupõe, no entanto, que os clipes/agramos sejam dispostos na parte traseira do compartimento de papel (lado oposto ao utilizador). A fim de prolongar a vida útil do aparelho, recomenda-se, contudo, a remoção dos clipes/agramos antes da trituração. Em casos individuais, dependendo da quantidade e da posição dos clipes/agramos, bem como da espessura da pilha de papel unida, podem ocorrer falhas na introdução e, conseqüentemente, interrupções na operação de trituração.

Desgaste, danos provocados por uma utilização incorreta, assim como intervenções por parte de terceiros, não estão abrangidos pela garantia, nem o fabricante assume qualquer responsabilidade pelos mesmos

A trituradora de papel foi concebida para uso doméstico e para o funcionamento num ambiente de escritório normal.

No que se refere ao desempenho em termos de folhas indicado nos dados técnicos, aplicam-se as seguintes condições básicas:

Número máximo de folhas cortadas de uma só vez, sob as seguintes condições de funcionamento: Rolos de corte novos ou possivelmente oleados, motor frio, rede elétrica com tensão nominal e frequência nomi-



1.2 Indicações de segurança

nal (230 V/50 Hz; 120 V/60 Hz). O não cumprimento destas condições de funcionamento pode levar a um desempenho reduzido em termos de folhas e ao aumento de ruídos de funcionamento.

As folhas devem ser introduzidas centralmente e longitudinalmente a 90°. As propriedades do papel e a sua forma de introdução também podem alterar o desempenho em termos de folhas.

- Não colocar o aparelho perto de uma fonte de calor!
- Armazenar, transportar ou utilizar o aparelho exclusivamente na vertical!
- Utilizar no aparelho apenas líquidos e gases que correspondam às diretivas DAHLE!
- Não abrir o aparelho!
- O aparelho deve ser operado exclusivamente em espaços fechados, a uma temperatura entre os 10 °C e os 25 °C (50 °F e 77 °F) e uma humidade atmosférica não condensada de 15% a 95%!
- Providenciar a proteção contra curto-circuito na instalação dos edifícios: máx. 16 A (EUA: máx. 20 A).
- Não utilizar o aparelho em vazio!
- Este aparelho não é indicado para utilização por pessoas (incluindo crianças) com capacidades físicas, sensoriais ou mentais reduzidas ou com pouca experiência e conhecimento, exceto se forem supervisionadas durante o trabalho ou receberem instruções relativamente à utilização do aparelho por uma pessoa responsável pela sua segurança.



Elimine a trituradora de papel de forma adequada e compatível com o meio ambiente num ponto de recolha autorizado. Não coloque nenhuma peça da trituradora de papel ou a embalagem no lixo doméstico.

**1.3 Legenda dos pictogramas**

Informações importantes



Ler as informações ao utilizador/indicações de segurança

**ATENÇÃO**

Não utilizar junto de materiais ácidos.



Pousar o aparelho de forma estável no chão e com uma distância de 100 mm da parede. Evitar a acumulação de calor. Acionar os travões de fixação (consoante o modelo)



Não utilizar junto de líquidos ou gases inflamáveis.



Iniciação automática



Não expor à humidade.



Esta trituradora de papel não se destina a ser utilizada por crianças (o produto não é nenhum brinquedo).



Não toque com as mãos na alimentação do papel.



Não toque com a roupa na alimentação do papel!



Não toque com os cabelos na alimentação do papel!



Mantenha latas de aerossol afastadas do dispositivo!



Remover agrafos e cliques antes do processo de trituração!



Não inserir disquetes!



Ao destruir CDs/DVDs, usar óculos de proteção!



Antes dos trabalhos de manutenção, desligar a trituradora de papel da rede elétrica!



Dados técnicos – Sujeito a alterações técnicas!



Volume de funcionamento em vazio



Velocidade de recolhimento



Corte de papel em partículas



Corte de CDs/DVDs em partículas



Corte de cartões em partículas



Peso



A ficha serve de dispositivo separador da alimentação de energia.



A tomada deve situar-se perto do aparelho e estar facilmente acessível!



Operação



Trituradora de papel operacional



Trituradora de papel em funcionamento



Desativação automática!



Após um funcionamento prolongado e/ou sobrecarga, a trituradora de papel desliga-se automaticamente para arrefecer.



Indicações de manutenção/eliminação de avarias



Recipiente cheio



Possíveis avarias



Desativação automática no caso de abertura da caixa

**OPGELET!**

VOOR u de papiervernietiger gebruikt, moet u aandachtig de handleiding en veiligheidsaanwijzingen lezen!

Volg alle veiligheidsvoorschriften!

Bewaar de handleiding voor later gebruik.

**Inhoudsopgave**

1	Belangrijke informatie	22
1.1	Bedoeld gebruik, garantieaanspraak	22
1.2	Veiligheidsaanwijzingen	23
1.3	Legenda van pictogrammen	24
1.4	Leveringsomvang.	88
1.5	Technische gegevens	88
2	Bediening	89
2.2	Apparaat op het stroomnet aansluiten	89
2.3	Apparaat inschakelen.	89
2.4	Papiervernietiging	90
2.10	Constante loopmodus	92
2.11	Vergrendeling	93
2.14	CD/DVD-, kaartvernietiging.	94
3	Onderhoud/probleemoplossing	96
3.1	Versnipperd materiaal verwijderen	96
3.3	Opvangbak/deksel open	96
3.4	Oververhitting.	97
3.5	Papierverstopping manuele toevoer	97
3.7	Papierverstopping automatische toevoer.	98
3.10	Papierverstopping vergrendelde automatische toevoer	99
3.13	Noodontgrendeling zonder sleutel	100
3.17	Apparaat reinigen	101

1.1 Bedoeld gebruik, garantieaanspraak

De papiervernietiger is bedoeld voor het versnipperen van papier.

Afhankelijk van de modelvariant kunnen naast papier ook kleine hoeveelheden van de volgende materialen worden vernietigd:

- cd's/dvd's, betaalpasjes en creditcards (zie Technische gegevens).
- In papieren documenten aanwezige nietjes en paperclips (uitzondering: apparaten met veiligheidsniveau P6 en P7).

Het apparaat beschikt over een automatische toevoer voor stapels vellen, die uit niet-gevouwd afzonderlijke vellen (max. 100 g/m²) bestaan. Papier met paperclips of nietjes kan doorgaans ook worden verwerkt. Voorwaarde hiervoor is dat de paperclips of nietjes aan de achterzijde van de papierlade worden geplaatst (van de gebruiker weg gericht). Om de levensduur van het apparaat te verlengen, wordt echter aanbevolen om de paperclips/nietjes te verwijderen voordat u het papier vernietigt. In individuele gevallen, afhankelijk van de hoeveelheid en de positie van de paperclips/nietjes en de omvang van de stapel geniete vellen, kan de toevoer worden verstoord en kan het vernietigingsproces worden onderbroken.

Slijtage of schade door onjuist gebruik vallen niet als ingrepen van derden noch onder de garantieaanspraak, noch onder de garantie

De papiervernietiger is ontworpen voor privé gebruik en normaal gebruik in een kantooromgeving.

De volgende voorwaarden zijn van toepassing op de prestaties van het vel gespecificeerd onder technische gegevens:

Maximumaantal vellen in één keer gesneden onder de volgende omstandigheden: Nieuwe of geoliede snijrollen, koude motor, voeding met nominale spanning en nominale frequentie (230 V/50 Hz, 120 V/60 Hz).

1.2 Veiligheidsaanwijzingen

Afwijkingen kunnen leiden tot lagere prestaties en meer geluid.

De vellen worden in het midden en in de lengte onder 90° ingevoerd. Afhankelijk van de papiereigenschappen en invoer, kan de veluitvoer ook variëren.

- Het apparaat niet in de nabijheid van warmtebronnen opstellen!
- Het apparaat uitsluitend rechtop staand bewaren, transporteren en gebruiken!
- Gebruik voor het apparaat uitsluitend vloeistoffen en gassen die aan de DAHLE-richtlijnen voldoen!
- Het apparaat mag niet worden geopend!
- Het apparaat alleen gebruiken in gesloten ruimtes met een omgevingstemperatuur van 10 °C tot 25 °C (50 °F tot 77 °F) en een niet-condenserende luchtvochtigheid van 15% tot 95%!
- Er moet een kortsluitingszekering in de elektrische installatie van het gebouw aanwezig zijn van max. 16A (VS 20A).
- Het apparaat niet leeg gebruiken!
- Het apparaat is niet bedoeld voor gebruik door personen (inclusief kinderen) met verminderde lichamelijke, zintuiglijke of verstandelijke vermogens of gebrek aan ervaring en kennis, tenzij ze werken onder toezicht of instructies krijgen over het gebruik van het apparaat door een persoon die verantwoordelijk is voor de veiligheid.



Lever voor een milieuvriendelijke en vakkundige afvalverwerking de papiervernietiger in bij een bevoegd verwerkingsbedrijf. Zet geen delen van de papiervernietiger of het verpakkingsmateriaal bij het huisvuil.

1.3 Legenda van pictogrammen

-  Belangrijke informatie
-  Gebruikersinformatie/veiligheidsaanwijzingen lezen
-  Waarschuwing
-  Niet gebruiken in de nabijheid van agressieve stoffen.
-  Zet het apparaat op een stabiele ondergrond op minstens 10 cm van de muur. Voorkom warmteaccumulatie. Vastzetremmen gebruiken (modelafhankelijk)
-  Niet gebruiken in de nabijheid van ontvlambare vloeistoffen of gassen.
-  Automatische start
-  Niet aan vochtigheid blootstellen.
-  Deze papiervernietiger is niet bedoeld voor gebruik door kinderen (dit product is geen speelgoed).
-  Raak de papierinvoeropening niet aan met uw handen.
-  Houd kledingstukken uit de buurt van de papierinvoeropening!
-  Blijf met uw haar uit de nabijheid van de papierinvoeropening!
-  Houd spuitbussen uit de buurt van de papiervernietiger!
-  Voor men papier versnipperd, moet men paperclips en nietjes verwijderen!
-  Geen diskettes invoeren!
-  Draag een veiligheidsbril bij het vernietigen van een cd/dvd!
-  Alvorens onderhoudswerkzaamheden aan de papiervernietiger uit te voeren, moet men de stekker uit het stopcontact halen!

-  Technische gegevens - technische wijzigingen onder voorbehoud!
-  Werkingsgeluidsterkte bij onbelast gebruik
-  Doorvoersnelheid
-  Papiersnippers snijden
-  CD/DVD-snippers snijden
-  Kaartsnippers snijden
-  Gewicht
-  De stroomstekker dient als ontkoppelinrichting van de stroomvoorziening.
-  Het stopcontact moet dicht bij het apparaat worden geplaatst en gemakkelijk bereikbaar zijn!
-  Bediening
-  Papiervernietiger gereed
-  Papiervernietiger in bedrijf
-  Automatische uitschakeling!
-  Bij langdurig gebruik en/of overbelasting wordt de papiervernietiger voor afkoeling automatisch uitgeschakeld.
-  Onderhoudsaanwijzingen/storingen verhelpen
-  Opvangbak vol
-  Mogelijke storingen
-  Automatische uitschakeling bij open behuizing

da Betjeningsvejledning



GIV AGT!

Læs betjeningsvejledningen og sikkerhedsanvisningerne til makulatoren nøje, FØR den tages i brug.



Anvisningerne skal følges!

Opbevar betjeningsvejledningen til senere anvendelse.

1.1 Tilsigtet anvendelse, garanti

Makulatoren er beregnet til makulering af papir. Alt efter model og variant kan der desuden makuleres små mængder af følgende materialer:

- cd'er/dvd'er, check- og kreditkort (se tekniske data).
- hæfteklammer og papirclips i papirdokumenter, i normalt omfang (undtagelse: apparater på sikkerhedsniveau P6 og P7).

Indholdsfortegnelse

1	Vigtige oplysninger	25
1.1	Tilsigtet anvendelse, garanti	25
1.2	Sikkerhedsanvisninger	26
1.3	Forklaring af symboler	27
1.4	Pakkens indhold	88
1.5	Tekniske data	88
2	Betjening	89
2.2	Tilslutning til strømforsyningsnettet	89
2.3	Tænde apparatet	89
2.4	Papirmakulering	90
2.10	Kontinuerlig drift	92
2.11	Aflåsning	93
2.14	CD-, DVD- og kortmakulering	94
3	Vedligeholdelse/fejlfhjælpning	96
3.1	Tømning	96
3.3	Beholder/dæksel åben	96
3.4	Overophedning	97
3.5	Papirblokering – manuel indtrækning	97
3.7	Papirblokering – automatisk indtrækning	98
3.10	Papirblokering – låst automatisk indtrækning	99
3.13	Nødoplåsning uden nøgle	100
3.17	Renholdelse	101

Apparatet er forsynet med en automatisk indtrækningsmekanisme til papirstabler bestående af ikke-foldede enkeltblade (maks. 100 g/m²). Papir, der er sammenhæftet med papirclips eller hæfteklammer, kan normalt også makuleres. I så fald skal klammerne befinde sig på papirpakkens bageste side (i retning væk fra brugeren). For at forlænge apparatets levetid anbefales det dog, at papirclips/hæfteklammer fjernes inden makuleringen. I enkeltstående tilfælde – alt efter mængden af klammer og deres position samt omfanget af den sammenhæftede papirstabel – kan der ske fejl i indtrækningen, hvilket vil afbryde makuleringsprocessen.

Slid, beskadigelse på grund af forkert anvendelse samt indgreb udført af tredjemand er hverken omfattet af garantien eller producentens hæftelse.

Makulatoren er konciperet til brug i private husholdninger og almindelige kontormiljøer.

Følgende rammebetingelser er gældende for det maksimale antal ark, der er angivet i de tekniske data: Maksimalt antal ark, der kan makuleres på én gang under følgende betingelser: Nye eller smurte skærevælsere, kold motor, strømforsyning med mærkespænding og mærkefrekvens (230 V/50 Hz; 120 V/60 Hz). Afvigelser kan medføre, at der kan makuleres et mindre antal ark og et forhøjet støjniveau under makuleringen.



1.2 Sikkerhedsanvisninger

Arkene tilføres midt i spalten og på langs under 90°. Antallet af ark, der kan makuleres, kan også variere, alt efter papirets egenskaber og tilføringen.

- Apparatet må ikke opstilles i nærheden af en varmekilde!
- Apparatet må kun opbevares, transporteres og anvendes opretstående!
- Brug kun væsker og gasser ved apparatet som opfylder retningslinjerne fra DAHLE.
- Apparatet må ikke åbnes!
- Apparatet må kun benyttes i lukkede rum ved 10–25 °C (50–77 °F) og ved en ikke-kondenserende luftfugtighed på mellem 15 % og 95 %!
- Tjek at strømforsyningen er sikret på bygningssiden: maks. 16 A (US maks. 20 A).
- Lad ikke apparatet køre i tomgang!
- Apparatet er ikke bestemt til brug af personer (herunder børn) med nedsatte fysiske evner, sansefunktioner eller mentale færdigheder eller manglende erfaring og viden, med mindre de arbejder under opsyn eller får udførlig vejledning i brugen af apparatet af en sikkerhedsansvarlig person.



Makulatorens skal bortskaffes på fagligt og miljømæssigt forsvarlig vis på en autoriseret genbrugsplads. Ingen del af makulatorens eller indpakningens må bortskaffes sammen med husholdningsaffald.



1.3 Forklaring af symboler



Vigtige oplysninger



Læs brugeroplysninger/sikkerhedsanvisninger



GIV AGT!



Må ikke anvendes i nærheden af ætsende stoffer.



Makulatorens skal opstilles, så den står sikkert på gulvet, og i en afstand på 100 mm fra væggen, så varmen kan slippe væk. Aktiver fastgøringsbremserne (afhænger af typen)



Må ikke anvendes i nærheden af brandbare væsker og gasser.



Automatisk start



Må ikke udsættes for fugt.



Denne makulator er ikke beregnet til at blive brugt af børn (produktet er ikke legetøj).



Rør ikke ved papirtilførslen med hænderne.



Rør ikke ved papirtilførslen med beklædningsgenstande!



Rør ikke ved papirtilførslen med håret!



Hold spraydåser fjernt fra apparatet!



Fjern klips og hæfteklammer før makulering!



Sæt ikke disketter i!



Ved destruktion af cd'er/dvd'er skal der bæres beskyttelsesbrille



Før der foretages vedligeholdelse af makulatorens, skal der slukkes for strømtilførslen!



Tekniske data - Forbeholdt tekniske ændringer!



Lydniveau i tomgang



Indtrækshastighed



Papir-partikelsnit



Cd/dvd-partikelsnit



Kort-partikelsnit



Vægt



Stik tjener som skilleanordning i strømfor- syningen.



Stikdåsen skal være i nærheden af appa- ratet og være let tilgængelig!



Betjening



Makulator i stand-by



Makulator i drift



Automatisk slukning!



Makulatorens slukker automatisk efter læn- gere tids drift og/eller overbelastning for at køle af.



Vedligeholdelsesanvisninger/afhjælpning af fejl



Opsamlingsbeholderen er fuld



Mulige fejl



Automatisk slukning ved åbent kabinet

**HUOMIO!**

Lue käyttö- ja turvallisuusohjeet huolellisesti ENNEN asiakirjasilppurin käyttöönottoa!



Ohjeita on noudatettava!

Säilytä käyttöohje myöhempiä käyttöä varten.

Sisällys

1	Tärkeitä tietoja	28
1.1	Tarkoituksenmukainen käyttö, tuotevastuu	28
1.2	Turvallisuusohjeet	29
1.3	Merkkien selitykset	30
1.4	Toimitussisältö	88
1.5	Tekniset tiedot	88
2	Käyttö	89
2.2	Laitteen liittäminen verkkovirtaan	89
2.3	Laitteen kytkeminen päälle	89
2.4	Paperin silppuaminen	90
2.10	Kestokäyttö	92
2.11	Lukitus	93
2.14	CD/DVD-levyjen, korttien silppuaminen	94
3	Huolto/häiriönpoisto	96
3.1	Leikkuujätteen tyhjentäminen	96
3.3	Säiliö/kansi auki	96
3.4	Ylikuumentuminen	97
3.5	Paperitukoksen manuaalinen poistaminen	97
3.7	Paperitukoksen automaattinen poistaminen	98
3.10	Paperitukoksen lukittu automaattinen poistaminen	99
3.13	Hätälukitus ilman avainta	100
3.17	Laitteen puhdistaminen	101

1.1 Tarkoituksenmukainen käyttö, tuotevastuu

Asiakirjasilppuri on tarkoitettu paperin silppuamiseen.

Mallista riippuen voidaan myös tuhota pieniä määriä seuraavia materiaaleja:

- CD-/DVD-levyt ja maksukortit (katso "Tekniset tiedot").
- paperiasiakirjoissa, käytössä tavanomaisena määränä, olemassa olevat niitit ja paperiliittimet (poikkeus: turvallisuustasojen P6 ja P7 laitteet).

Laitteessa on automaattinen syöttö arkkipinoille, jotka koostuvat taittamattomista yksittäisistä arkeista (maks. 100 g/m²). Nidottu paperi, sekä paperiliittimillä että niiteillä, voidaan yleensä käsitellä. Edellytyksenä on liittimien sijoittaminen paperilokeron takaosaan (poispäin käyttäjästä). Laitteen käyttöä pidetään pidettäväksi on kuitenkin suositeltavaa poistaa niitit/paperiliittimet ennen silppuamista. Yksittäisissä tapauksissa liittimien määrästä ja sijainnista sekä nidottujen arkkipinojen määrästä riippuen saattaa aiheutua virheellinen syöttö ja siten silppuamisprosessin keskeytyminen.

Kuluminen, epäasianmukaisesta käytöstä johtuvat vauriot sekä ulkopuolisen suorittamat toimenpiteet eivät kuulu tuotevastuun eivätkä takuun piiriin

Asiakirjasilppuri on suunniteltu käytettäväksi yksityiskodeissa ja normaalissa toimistoympäristössä. Teknisissä tiedoissa ilmoitetun suorituskyvyn saavuttaminen riippuu seuraavista seikoista: Yksittäisten, silputtavien arkkiänten enimmäismäärä seuraavissa olosuhteissa: Uudet tai öljytyt leikkausterät, kylmä moottori, tehollinen nimellisjännitteellä ja -taajuudella (230 V/50 Hz, 120 V/60 Hz). Näistä poikkeaminen voi johtaa huonompaan suorituskykyyn ja melun lisääntymiseen.

1.2 Turvallisuusohjeet

Arkit syötetään keskitetysti ja pituussuunnassa, 90° kulmassa. Arkkien käsittelyteho voi myös vaihdella paperin ominaisuuksista ja syöttötavasta riippuen.

- Älä aseta laitetta lämmönlähteen lähelle!
- Säilytä, kuljeta ja käytä laitetta ainoastaan pystyasennossa!
- Käytä laitteessa vain nesteitä ja kaasuja, jotka täyttävät DAHLEN vaatimukset!
- Käytä laitetta ainoastaan suljetuissa tiloissa 10–25 °C:ssa (50–77 °F:ssa) ja tiivistymättömässä 15–95 %:n ilmankosteudessa!
- Laitetta ei saa avata!
- Rakennuksen asennusten oikosulkusuojaus on taatava: maks. 16 A (US maks. 20 A).
- Älä käytä laitetta tyhjänä!
- Laitetta ei ole tarkoitettu sellaisten henkilöiden käytettäväksi (lapset mukaan luettuna), joiden fyysiset, aistilliset tai henkiset kyvyt ovat rajoitettuja tai joilta puuttuu kokemus ja tieto, elleivät he työskentele valvonnan alaisina tai saa perusteellista ohjetta laitteen käytöstä turvallisuudesta vastaavalta henkilöltä.



Hävitä asiakirjasilppuri ammattimaisesti ja ympäristöystävällisesti valtuutetussa keräyspisteessä. Asiakirjasilppurin osia tai pakkausta ei saa laittaa talousjätteen sekaan.



1.3 Merkkien selitykset



Tärkeä tieto



Tietoa käyttäjälle/lue turvallisuusohjeet



HUOMIO



Asiakirjasilppuria ei saa käyttää syövyttävien aineiden läheisyydessä.



Aseta laite tukevasti lattialle 100 mm:n etäisyydelle seinästä, vältä kuumentumista suman vuoksi, lukitse seisontajarrut (malista riippuvainen)



Asiakirjasilppuria ei saa käyttää palavien nesteiden tai kaasujen läheisyydessä.



Automaattinen käynnistys



Ei saa altistua kosteudelle



Tämä asiakirjasilppuri ei sovellu lasten käyttöön (laite ei ole leikkikalua).



Paperinsyöttöön ei saa koskea käsin.



Paperinsyöttöön ei saa laittaa vaatekapaleita!



Paperinsyöttöön ei saa laittaa hiuksia!



Pidä spraypullot kaukana!



Paperiliittimet ja niitit on poistettava ennen silppuamista!



Älä syötä diskettejä!



CD-/DVD-levyjä hävitettäessä on käytettävä suojalaseja!



Irrota asiakirjasilppuri virtalähteestä ennen huoltotoita!



Tekniset tiedot – Oikeudet teknisiin muutoksiin pidätetään!



Äänvoimakkuus tyhjäkännissä



Sisäänvetonopeus



Paperin silppuleikkaus



CD/DVD-levyjien silppuleikkaus



Korttien silppuleikkaus



Paino



Verkkopistoke toimii virtalähteen katkaisijana.



Pistorasian on oltava laitteen lähellä ja helposti saatavilla!



Käyttö



Asiakirjasilppuri valmiustilassa



Asiakirjasilppuri toiminnassa



Automaattinen sammutus!



Pidempiäikäisessä käytössä ja/tai ylikuormituksen vuoksi asiakirjasilppuri kytkeytyy automaattisesti pois päältä jäähtymään.



Huolto-ohjeet/häiriöiden korjaus



Silppusäiliö täynnä



Mahdolliset häiriöt



Automaattinen sammutus avatulla kotelolla

**no Bruksanvisning****OBS!**

FØR du tar i bruk makuleringsmaskinen må du lese nøye gjennom bruksanvisningen og sikkerhetsinstruksene.

Anvisningene må anvendes!

Oppbevar bruksanvisningen for senere bruk.

**Innholdsfortegnelse**

1	Viktig informasjon	31
1.1	Forskriftsmessig bruk, garanti	31
1.2	Sikkerhetsinstrukser	32
1.3	Piktogramforklaring	33
1.4	Leveringsomfang	88
1.5	Tekniske data	88
2	Betjening	89
2.2	Koble apparatet til strømmettet	89
2.3	Slå på apparatet	89
2.4	Papirmakulering	90
2.10	Kontinuerlig fremdrift	92
2.11	Låsing	93
2.14	CD/DVD-, kortmakulering	94
3	Vedlikehold/feilretting	96
3.1	Tøm skjæregods	96
3.3	Beholder/deksel er åpen(t)	96
3.4	Overopphetet	97
3.5	Papirfeil, manuell inntrekking	97
3.7	Papirfeil, automatisk inntrekking	98
3.10	Papirfeil, låst automatisk inntrekking	99
3.13	Nødopplåsing uten nøkkel	100
3.17	Rengjør apparatet	101

1.1 Forskriftsmessig bruk, garanti

Makuleringsmaskinen er konstruert for å makulere papir.

Avhengig av hvilken modell det dreier seg om, kan dessuten en liten mengde av de følgende materia-
lene makuleres:

- CD-er/DVD-er, sjekk- og kredittkort (se Tekniske data).
- Binders og stifter som finnes i papirdokumenter i vanlig omfang (unntak: enheter i sikkerhetstrinn P6 og P7).

Apparatet har automatisk inntrekking for arkstabel som består av ubrettede enkeltark (maks. 100 g/m²). Sammenheftet papir, enten det er med binders eller stifter, kan vanligvis også bearbeides. Forutsetningen for dette er at heftemiddelet befinner seg på baksiden av papirskuffen (vendt bort fra brukeren). For å forlenge apparatets levetid anbefaler vi imidlertid at binders/stifter fjernes før makulering. I enkeltstående tilfeller kan det, avhengig av heftemidlenes mengde og posisjon samt størrelsen på den sammenheftede arkstabelen, oppstå feilinntrekk og dermed avbrudd i makuleringsprosessen.

Slitasje, skader på grunn av ikke fagmessig bruk, samt inngrep fra tredjepart faller verken inn under forhandlergaranti eller produsentgaranti

Makuleringsmaskinen er konstruert til privat drift samt drift i normale kontoromgivelser.

Med hensyn til arkkapasiteten angitt under tekniske data gjelder følgende rammebetingelser:

Maksimalt antall ark som kan kuttes i en gjennomgang under følgende betingelser: Nye eller smurte kuttevalser, kald motor, strømforsyning med nominell spenning og frekvens (230 V/50 Hz; 120 V/60 Hz). Avvik kan føre til en lavere arkkapasitet og høyere driftsstøy.



Arkene mates inn midtstilt og i lengderetningen ved 90°. Arkkapasiteten kan også variere alt etter papi-regnskaper og tilførsel.

1.2 Sikkerhetsinstruksjer

- Apparatet må ikke plasseres i nærheten av en varmekilde!
- Apparatet må kun lagres, transporteres og brukes stående!
- Man må kun benytte væsker og gass som tilsvarer DAHLE-direktivene på apparatet!
- Apparatet skal ikke åpnes!
- Ikke la apparatet gå på tomgang!
- Apparatet skal kun brukes i lukkede rom ved temperaturer fra 10 °C til 25 °C (50 °F bis 77 °F) og en ikke-kondenserende luftfuktighet fra 15 % til 95 %!
- Det må sørges for sikkerhet mot kortslutning av bygningsinnstallasjonen: maks. 16 A (US maks. 20 A).
- Matekanaler må kun brukes enkeltvis!
- Apparatet er ikke bestemt til bruk av personer (gjelder også barn) med innskrenkede fysiske, sensoriske eller åndelige evner eller manglende erfaring og kunnskaper, med mindre de arbeider under tilsyn eller får en utførlig veiledning til bruken av apparatet av en person som er ansvarlig for sikkerheten.



Makuleringsmaskinen må kastes faglig korrekt og miljøvennlig ved et autorisert samlested for avfall. Ingen deler av makuleringsmaskinen eller emballasjen får kastes i husholdningsavfallet.

1.3 Piktogramforklaring

-  Viktig informasjon
-  Les brukerinformasjonen/sikkerhetsinstruksene
-  OBS
-  Må ikke benyttes i nærheten av etsende stoffer.
-  Apparatet må plasseres stabilt på gulvet med en avstand på 100 mm til veggen, unngå oppvarming på grunn av kø/blokking, Betjen parkeringsbremsen (typeavhengig)
-  Må ikke benyttes i nærheten av brennbare væsker eller gass.
-  Automatisk start
-  Må ikke utsettes for fuktighet
-  Denne makuleringsmaskinen er ikke ment til bruk av barn (produktet er ikke et leketøy).
-  Ikke berør papirinntaket med hendene.
-  Ikke berør papirinntaket med klesplagg!
-  Ikke berør papirinntaket med hårene!
-  Spraybokser må holdes unna!
-  Fjern binders og heftestifter før makulering!
-  Ikke før inn disketter!
-  Når du ødelegger CD/DVD-er må du bruke en vernebrille!
-  Før vedlikeholdsarbeid må makuleringsmaskinen kobles fra strømmettet!

-  Tekniske data - Forbehold om tekniske endringer!
-  Driftslydstyrke på tomgang
-  Inntrekkshastighet
-  Papir-partikkelsnitt
-  CD/DVD-partikkelsnitt
-  Kort-partikkelsnitt
-  Vekt
-  Strømkontakten brukes som skilleanordning for strømforsyningen.
-  Stikkontakten skal befinne seg i apparatets umiddelbare nærhet og være lett tilgjengelig!
-  Betjening
-  Makuleringsmaskin i beredskap
-  Makuleringsmaskin i drift
-  Automatisk utkobling!
-  Ved lengre drift og/eller overbelastning slås makuleringsmaskinen automatisk av for avkjøling.
-  Vedlikeholdsinstrukser/feilretting
-  Beholder full
-  Mulige feil
-  automatisk utkobling ved åpent hus

**OBS!**

Läs uppmärksamt igenom bruksanvisningen och säkerhetsanvisningarna INNAN dokumentförstöraren tas i drift. Anvisningarna måste tillämpas! Förvara bruksanvisningen för senare användning.

**Innehållsförteckning**

1	Viktig information	34
1.1	Ändamålsenlig användning, garanti	34
1.2	Säkerhetsanvisningar	35
1.3	Piktogramförklaring	36
1.4	Leveransens omfattning	88
1.5	Tekniska data	88
2	Manövrering	89
2.2	Ansluta apparaten till elnätet	89
2.3	Slå på apparaten	89
2.4	Förstöra dokument	90
2.10	Permanent drift	92
2.11	Spärr	93
2.14	Förstöra CD/DVD-skivor och kort	94
3	Underhåll/felavhjälpning	96
3.1	Tömning av skuret material	96
3.3	Behållare/lock öppet	96
3.4	Överhettning	97
3.5	Pappersblockering manuell inmatning	97
3.7	Pappersblockering automatisk inmatning	98
3.10	Pappersblockering spärrad automatisk inmatning	99
3.13	Nödoplåsning utan nyckel	100
3.17	Rengöring av apparaten	101

1.1 Ändamålsenlig användning, garanti

Dokumentförstöraren är avsedd för förstörelse av papper. Allt efter modellvariant kan dessutom smärre mängder av följande material förstöras:

- cd-/dvd-skivor, bank- och kreditkort (se Tekniska data).
- vanliga häftklamrar och gem som används i pappersdokument (undantag: apparater med säkerhetsnivå P6 och P7).

Apparaten har automatisk inmatning av pappersbuntar bestående av ovikta enskilda ark (max. 100 g/m²). Häftade papper, både med gem och häftklamrar, kan som regel bearbetas. Förutsatt att gemen och häftklamrarna är placerade mot den bakre sidan av pappersfacket (bort från användaren). För att förlänga apparatens livslängd, rekommenderar vi ändå att ta bort gem och häftklamrar innan pappren ska förstöras. I enskilda fall, beroende på mängd och placering av gem och häftklamrar samt omfånget hos den häftade pappersbuntens, kan inmatningen störas vilket kan leda till att förstörelseprocessen avbryts.

Slitage, skador på grund av felaktig användning samt ingrepp som utförs av tredje part faller varken under den lagstadgade garantin eller tillverkarens garanti.

Dokumentförstöraren är utformad för att användas privat och i vanlig kontorsmiljö. För bladeffekten som anges under tekniska data gäller följande förutsättningar: Maximalt antal blad som får skäras i en genomgång under följande förutsättningar: Nya eller oljade skärvalsar, kall motor, strömförsörjning med märkspänning och märkfrekvens (230 V/50 Hz, 120 V/60 Hz). Avvikelser kan leda till lägre bladeffekt och ökat driftsljud.

Bladen matas in centrerat och på längden under 90°. Bladeffekten kan också variera beroende på pappersegenskaper och inmatning.

1.2 Säkerhetsanvisningar

- Ställ inte upp apparaten i närheten av en värmekälla!
- Förvara, transportera och använd apparaten endast stående!
- Använd endast vätskor och gaser på apparaten som motsvarar DAHLE-riktlinjerna!
- Apparaten får inte öppnas!
- Använd endast apparaten inomhus, vid 10 °C till 25 °C (50 °F till 77 °F) och en ej kondenserande luftfuktighet på 15 % till 95 %!
- Se till att fastighetens installation är kortslutnings säker: max. 16 A (USA max. 20 A).
- Använd inte apparaten på tomgång!
- Apparaten är inte avsedd att användas av personer (inklusive barn) med nedsatt fysisk, sensorisk eller mental kapacitet eller bristande erfarenhet och kunskap, såvida de inte arbetar under uppsikt eller erhåller en utförlig anvisning om hur apparaten används av en person som ansvarar för säkerheten.



Avfallshantera dokumentförstöraren korrekt och miljörättigt hos ett auktoriserat uppsamlingsställe. Kasta in några delar av dokumentförstöraren eller förpackningen i hushållssoporna.



1.3 Piktogramförklaring



Viktig information



Läs användarinformationen/säkerhetsanvisningarna



OBS!



Använd inte apparaten i närheten av frätande ämnen.



Placera apparaten stabilt på golvet och med 100 mm avstånd till väggen, undvik värmeackumulering, använd parkeringsbromsen (typberoende)



Använd inte apparaten i närheten av brännbara vätskor eller gaser.



Automatisk start



Utsätt inte apparaten för väta.



Denna dokumentförstörare får inte användas av barn (produkten är ingen leksak)!



Vidrör inte pappersinmatningen med händerna.



Vidrör inte pappersinmatningen med klädesplagg!



Vidrör inte pappersinmatningen med håret!



Håll sprayburkar på avstånd!



Ta bort gem och häftklammer före förstörelseprocessen!



Lägg inte in några disketter!



Ha på dig skyddsglasögon när du förstör cd-/dvd-skivor!



Koppla bort dokumentförstöraren från elnätet innan underhållsarbeten påbörjas!



Tekniska data - Med reservation för tekniska ändringar!



Driftsljudnivå på tomgång



Inmatningshastighet



Papper partikelsnitt



CD/DVD partikelsnitt



Kort partikelsnitt



Vikt



Stickkontakten fungerar som fränskiljningsanordning för strömförsörjningen.



Uttaget bör finnas i närheten av apparaten och vara lätt tillgängligt!



Manövrering



Dokumentförstöraren i beredskap



Dokumentförstöraren i drift



Automatisk avstängning!



Vid längre drift och/eller överbelastning stängs dokumentförstöraren automatiskt av för att svalna.



Underhållsanvisningar/åtgärder vid störningar



Behållaren full



Möjliga störningar



automatisk fränkoppling vid öppet hölje



sl Navodilo za uporabo

**POZOR!**

PRED začetkom uporabe uničevalnika dokumentov pozorno preberite navodilo za uporabo in varnostne napotke.

Napotke morate upoštevati!

Navodilo za uporabo shranite za poznejšo uporabo.

**Kazalo vsebine**

1	Pomembne informacije	37
1.1	Namenska uporaba, jamstvo	37
1.2	Varnostna navodila	38
1.3	Legenda piktogramov	39
1.4	Obseg dobave	88
1.5	Tehnični podatki	88
2	Upravljanje	89
2.2	Priključitev naprave na električno omrežje	89
2.3	Vklop naprave	89
2.4	Uničevanje papirja	90
2.10	Neprekinjeno podajanje	92
2.11	Zapah	93
2.14	Uničevanje CD-jev/DVD-jev, kartic	94
3	Vzdrževanje/odpravljanje napak	96
3.1	Praznjenje razrezanega materiala	96
3.3	Odprta posoda/pokrov	96
3.4	Pregrevanje	97
3.5	Zastoj papirja pri ročnem podajanju	97
3.7	Zastoj papirja pri samodejnem podajanju	98
3.10	Zastoj papirja pri zapahnjem samodejnem podajanju	99
3.13	Odpahnitev v sili brez ključa	100
3.17	Čiščenje naprave	101

1.1 Namenska uporaba, jamstvo

Uničevalnik dokumentov je namenjen uničevanju papirja.

V odvisnosti od modela se lahko poleg papirja uničijo tudi majhne količine naslednjih materialov:

- CD/DVD, čekovne in kreditne kartice (glejte tehnične podatke).
- sponke za spenjanje in pisarniške sponke, ki so v običajnem obsegu vsebovane v papirni dokumentaciji (izjema: priprave varnostne stopnje P6 in P7).

Naprava je opremljena s samodejnim podajanjem za svežnje papirja iz neprepognjenih posameznih listov papirja (največ 100 g/m²). Praviloma je mogoče predelati tudi spete liste papirja. Pogoji je, da so sponke na zadnji strani predala za papir (obrnjene stran od uporabnika). Za daljšo življenjsko dobo naprave vseeno priporočamo, da sponke pred uničevanjem papirja odstranite. V določenih primerih, odvisno od količine in položaja sponk ter obsega spetih svežnjev papirja, lahko pride do napačnega podajanja in s tem prekinitve uničevanja.

Jamstvo in garancija ne pokrivata obrabe ter škode zaradi nepravilne uporabe in posegov tretjih oseb

Uničevalnik dokumentov je zasnovan za uporabo v zasebne namene in v običajnem pisarniškem okolju. Za spodaj navedene tehnične podatke o zmogljivosti obdelave listov veljajo naslednji robni pogoji: Največje število listov, ki jih je mogoče naenkrat razrezati pod naslednjimi pogoji: Novi in po potrebi naoljeni rezalni valji, hladen motor, električno napajanje z nazivno napetostjo ter frekvenco (230 V/50 Hz; 120 V/60 Hz). Odstopanja lahko povzročijo manjšo zmogljivost obdelave listov in glasnejše delovanje.



1.2 Varnostna navodila

Liste je treba dovajati po sredini in pod kotom 90°. Zmogljivost obdelave se lahko spreminja tudi glede na lastnosti papirja in način dovajanja.

- Naprave ne postavljajte v bližino virov toplote.
- Napravo skladiščite, transportirajte in uporabljajte izključno v pokončnem položaju!
- Na napravi uporabljajte samo tekočine in pline, ki ustrezajo smernicam podjetja DAHLE!
- Naprave ne smete odpirati!
- Zagotovite, da je napeljava v zgradbi zaščiten pred kratkim stikom: maks. 16 A (ZDA maks. 20 A).
- Aparat uporabljajte samo v zaprtih prostorih pri temperaturi 10 °C do 25 °C (50 °F do 77 °F) in pri zračni vlažnosti brez nevarnosti kondenziranja od 15 % do 95 %!
- Naprava ne sme obratovati v prostem teku!
- Aparat ni namenjen uporabi s strani oseb (vključno z otroki) z omejenimi fizičnimi, senzornimi ali duševnimi sposobnostmi ali s pomanjkljivimi izkušnjami in znanjem, razen, če delajo pod nadzorom ali pa jih oseba, odgovorna za varnost, temeljito pouči o uporabi naprave.



Uničevalnik dokumentov strokovno in okolju prijazno odvrzite med odpadke na pooblaščenem zbirnem mestu. Delov uničevalnika dokumentov ali embalaže ne mečite med hišne odpadke.



1.3 Legenda piktogramov



Pomembne informacije



Preberite uporabniške informacije/varnostne napotke



POZOR



Ne uporabljajte v bližini jedkih snovi.



Napravo postavite na tla v stabilen položaj 100 mm od stene, preprečite zadrževanje toplote, pritegnite fiksne zavore (odvisno od tipa)



Ne uporabljajte v bližini gorljivih tekočin ali plinov.



Avtomatski zagon



Ne izpostavljajte vlagi.



Tega uničevalnika dokumentov ne smejo uporabljati otroci (izdelek ni igrača).



Dovoda papirja se ne dotikajte z rokami.



Dovoda papirja se ne dotikajte z oblačili!



Dovoda papirja se ne dotikajte z lasmi!



Razpršilnike držite proč od naprave!



Pred uničevanjem dokumentov z njih odstranite vse sponke!



Ne vstavljajte disket!



Pri uničevanju plošč CD/DVD morate nositi zaščitna očala!



Pred vzdrževalnimi deli uničevalnik dokumentov odklopite od električnega napajanja!



Tehnični podatki - pridržujemo si pravico do tehničnih sprememb!



Obratovalna glasnost v prostem teku



Hitrost uvleka



Rezanje papirja na delce



Rezanje CD/DVD na delce



Rezanje kartic na delce



Teža



Omrežni vtič služi kot ločilna priprava električnega napajanja.



Vtičnica mora biti v bližini naprave in lahko dostopna.



Upravljanje



Uničevalnik dokumentov v pripravljenosti



Uničevalnik dokumentov v obratovanju



Avtomatski izklop!



Pri dolgotrajnem obratovanju in/ali preobremenitvi se uničevalnik dokumentov avtomatsko izklopi, da se ohladi.



Navodila za vzdrževanje / odpravljanje napak



Posoda je polna



Možne motnje



avtomatski izklop pri odprtem ohišju

**hr Upute za uporabu****PAŽNJA!**

PRIJE prve uporabe uništavača dokumenata pažljivo pročitajte Upute za uporabu i sigurnosne napomene i pridržavajte ih se!

Obavezno poštujujte sve napomene!

Sačuvajte ove upute za kasniju uporabu.

**1.1 Namjenska uporaba, jamstvo**

Uništavač dokumenata namijenjen je uništavanju papira.

Ovisno o vrsti modela, moguće je uništavanje manje količine sljedećih materijala:

- CD-i, DVD-i, čekovne i kreditne kartice (vidi Tehničke podatke).
- spajalice i klamerice koje se nalaze u papirnoj dokumentaciji u uobičajenoj količini (iznimka: uređaji sa stupnjem sigurnosti P6 i P7).

Sadržaj

1	Važne informacije	40
1.1	Namjenska uporaba, jamstvo	40
1.2	Sigurnosne upute	41
1.3	Legenda piktograma	42
1.4	Opseg isporuke	88
1.5	Tehnički podaci	88
2	Uporaba	89
2.2	Priključivanje uređaja na električnu mrežu ..	89
2.3	Uključivanje uređaja	89
2.4	Uništavanje dokumenata	90
2.10	Trajno uvlačenje	92
2.11	Blokiranje	93
2.14	Uništavanje CD-a, DVD-a, kartica	94
3	Održavanje/otklanjanje smetnji	96
3.1	Pražnjenje odrezaka	96
3.3	Otvoren spremnik/poklopac	96
3.4	Pregrijavanje	97
3.5	Zastoj papira ručnog uvlačenja	97
3.7	Zastoj papira automatskog uvlačenja	98
3.10	Zastoj papira blokiranog automatskog uvlačenja	99
3.13	Sigurnosno deblokiranje bez ključa	100
3.17	Čišćenje uređaja	101

Uređaj posjeduje automatsko uvlačenje složenih listova koji se ne sastoje od pojedinačno presa-vijenih papira (maks. 100 g/m²). Papir pričvršćen spajalicama ili klamericama u pravilu se također može obrađivati. Spajalice i klamerice pritom mora-ju biti raspoređene na stražnjoj strani pretinca za papir (na suprotnoj strani od korisnika). Kako bi se produljio vijek trajanja uređaja, preporučuje se prije uništavanja dokumenata ipak ukloniti spajalice/klamerice. U pojedinačnim slučajevima, ovisno o količini i položaju spajalica kao i količini hrpe listova pričvršćenih spajalicama ili klamericama, može doći do pogrešnog uvlačenja i time izazvanog prekida postupka uništavanja.

Trošenje, oštećenja zbog neprikladne uporabe i zahvati trećih strana nisu obuhvaćeni jamstvom ni garancijom

Uništavač dokumenata namijenjen je za privatnu uporabu i uobičajeno uredsko poslovanje. U vezi s količinom listova koja je navedena u tehničkim podacima, vrijede sljedeći okvirni uvjeti: Maksimalni broj listova koji se mogu izrezati u jed-nom prolazu pri sljedećim uvjetima: Novi i prema potrebi podmazani valjci za rezanje, hladan motor, napajanje strujom s nazivnim naponom i nazivnom frekvencijom (230 V/50 Hz; 120 V/60 Hz). Odstu-panja mogu dovesti do smanjene količine listova i povećane buke pri okretanju.



1.2 Sigurnosne upute

Listove treba umetati po sredini i uzdužno pod kutom od 90°. Ovisno o svojstvima papira i načinu umetanja, također može varirati i količina listova.

- Nemojte uređaj postaviti u blizini izvora topline!
- Ovaj stroj skladištite, prevozite i koristite isključivo u uspravnom položaju!
- Prilikom rada stroja koristite samo tekućine i plinove koji ispunjavaju zahtjeve iz smjernica tvrtke DAHLE!
- Uređaj se ne smije otvarati!
- Stroj ne smije raditi u praznom hodu!
- Uređaj upotrebljavajte isključivo u zatvorenim prostorima na temperaturi od 10 °C do 25 °C (50 °F do 77 °F) i na vlažnosti zraka bez kondenzacije od 15 % do 95 %!
- Instalacije zgrade treba osigurati od kratkog spoja: maks. 16 A (SAD maks. 20 A).
- Otvore za uvlačenje koristiti samo pojedinačno!
- Uređajem ne smiju rukovati osobe (uključujući djecu) s ograničenim fizičkim, osjetilnim ili intelektualnim sposobnostima ili s nedostatkom iskustva i znanja, osim ako rade pod nadzorom ili ih je osoba odgovorna za sigurnost iscrpno upoznala s rukovanjem uređajem.



Uništavač dokumenata zbrinite stručno i u skladu s propisima o zaštiti okoliša na ovlaštenom deponiju. Dijelove uništavača dokumenata ili ambalaže ne odlažite u kućanski otpad.



1.3 Legenda pitkograma



Važne informacije



Pročitajte korisničke informacije/sigurnosne napomene



PAŽNJA



Uređaj nemojte koristiti u blizini korozivnih tvari.



Stroj postavite na čvrsto tlo na udaljenosti 100 mm od zida i izbjegavajte gomilanje topline! Aktivirajte kočnice za zaustavljanje (ovisno o tipu)



Uređaj nemojte koristiti u blizini zapaljivih tekućina ili plinova.



Automatsko pokretanje uređaja



Uređaj nemojte izlagati vlazi



Ovim uništavačem dokumenata ne smiju rukovati djeca (proizvod nije igračka).



Otvor za ulaganje papira nemojte dodirivati rukama.



Otvor za ulaganje papira ne dodirujte komadima odjeće!



Otvor za ulaganje papira ne dodirujte kosom!



Držite podalje od sprejeva!



Prije uništavanja dokumenata ukloniti spajalice i klamerice!



Nemojte uvoditi diskete!



Prilikom uništavanja CD-a/DVD-a treba nositi zaštitne naočale!



Prije radova održavanja isključite uništavač dokumenata iz napajanja strujom!



Tehnički podaci - Pridržano pravo tehničkih izmjena!



Razina buke pri radu u praznom hodu



Brzina uvlačenja



Rezanje papira u sitne dijelove



Rezanje CD-a/DVD-a u sitne dijelove



Rezanje kartica u sitne dijelove



Masa



Utikač služi za odvajanje električnog napajanja



Utičnicu treba biti postavljena u blizini uređaja te lako dostupna!



Uporaba



Uništavač dokumenata u stanju pripravnosti



Uništavač dokumenata u radu



Automatsko isključivanje!



Kod dužeg rada i/ili preopterećenja uništavač dokumenata se automatski gasi radi hlađenja.



Napomene o održavanju/otklanjanje smetnji



Spremnik pun



Moguće smetnje



automatsko gašenje kod otvorenog kućišta

**hu** Használati utasítás**FIGYELEM!**

Az iratmegsemmítő üzembe helyezése ELŐTT figyelmesen olvassa el a kezelési és biztonsági utasításokat.

Az utasításokat alkalmazni kell.

Őrizze meg a kezelési utasítást a későbbi használatához.

**Tartalomjegyzék**

1	Fontos információk	43
1.1	Rendeltetés szerinti használat, garancia ...	43
1.2	Biztonsági előírások.....	44
1.3	A piktogramok jelmagyarázata.....	45
1.4	A szállítmány tartalma	88
1.5	Műszaki adatok	88
2	Kezelés	89
2.2	A készülék hálózatra kapcsolása	89
2.3	A készülék bekapcsolása.....	89
2.4	Papír megsemmítés	90
2.10	Tartós előre menet	92
2.11	Reteszelés	93
2.14	CD/DVD- és kártyamegsemmítés.....	94
3	Karbantartás/hibaelhárítás.....	96
3.1	A vágott anyag ürítése.....	96
3.3	Tároló/fedél nyitva	96
3.4	Túlmelegedés.....	97
3.5	Papír elakadás, kézi behúzás	97
3.7	Papír elakadás, automatikus behúzás	98
3.10	Papír elakadás, reteszelt automatikus behúzás	99
3.13	Vész-kioldás kulcs nélkül.....	100
3.17	A készülék tisztítása.....	101

1.1 Rendeltetés szerinti használat, garancia

Az iratmegsemmítő papírok megsemmítésére készült.

Egyes modellek kis mennyiségben alkalmasak a következő anyagok megsemmítésére is:

- CD-k/DVD-k, csekk- és hitelkártyák (lásd a műszaki adatokat).
- a papírdokumentumokban a szokásos felhasználói terjedelemben előforduló tűző- és irodai kapcsok (kivételek: P6 és P7 biztonsági fokozatú készülékek).

A készülék automatikusan behúzza a lapcsomagot, amely nem összehajtott (max. 100 g/m²) egyedi lapokból áll. Az iratfűzővel vagy gemkapocscsal összekapcsolt papír általában azzal együtt feldolgozható. Ennek feltétele, hogy a kapocs a papírrekesz hátsó oldala felé nézzen (a használóval ellentétesen). A készülék élettartamának meghosszabbítása érdekében azonban ajánlatos az iratfűző és gemkapcsokat a megsemmítés előtt eltávolítani. A kapcsok számától és elhelyezkedésétől és a papír csomag vastagságától függően, egyes esetekben hibás behúzás történhet, ami megszakítja a megsemmítési folyamatot.

A kopás, a szakszerűtlen használatból adódó károsodás és a harmadik fél általi beavatkozás nem tartozik sem a garancia, sem a szavatosság hatálya alá.

Az iratmegsemmítő magán vagy normál irodai környezetben való használatra készült.

A műszaki adatainak között megadott lapszámokra az alábbi feltételek vonatkoznak:

Az egy menetben vágható lapok legnagyobb száma az alábbi feltételek esetén érvényes: Új, adott esetben beolajozott vágóhengerek, hideg motor, névleges feszültségű és frekvenciájú áramellátás (230 V/50 Hz, 120 V/60 Hz). Az eltérések csökkenthetik a lapok számát és hangosabb működést eredményezhetnek.



1.2 Biztonsági előírások

A lapokat középen, hosszában 90°-ban kell bevezetni. A papír tulajdonságai és a bevezetés is csökkentheti a lapok számát.

- A készüléket nem szabad hőforrások közelében elhelyezni.
- A készülék kizárólag álló helyzetben tárolható, szállítható és üzemeltethető.
- A készülékhez csak olyan folyadékokat és gázokat használjon, amelyek megfelelnek a DAHLE előírásainak.
- A készüléket tilos felnyitni.
- A készüléket kizárólag zárt helyiségekben, 10 és 25 °C közötti hőmérsékleten, kondenzációmentes, 15 és 95% közötti páratartalom mellett üzemeltesse.
- Az épület elektromos hálózatában biztonsági rövidzárlat-védelmet kell felszerelni: max. 16A (US max. 20A).
- Ne működtesse üresen a készüléket.
- A készülék nem csökkent fizikai, érzékszervi vagy szellemi képességű, vagy tapasztalat és ismeretek nélküli személyek (ideértve a gyerekeket is) által történő használatra készült, kivéve, ha felügyelet mellett használják a készüléket vagy a készülék használatához részletes utasítást kapnak egy olyan személytől, aki a biztonságért felelős.



Az iratmegsemmisítőt szakszerű, környezetbarát módon selejtezze le és adja le egy átvételre jogosult gyűjtőhelyen. Az iratmegsemmisítő vagy a csomagolás semmilyen részét ne helyezze a háztartási hulladék közé.

**1.3 A piktogramok jelmagyarázata**

Fontos információ



Olvassa el a kezelési/biztonsági utasításokat



FIGYELEM



Ne használja maró anyagok környezetében.



A készüléket biztonságosan állítsa a talajra a faltól 100 mm távolságra és ne hagyja, hogy a hő felhalmozódjon benne. Nyomja le a rögzítőféket (típusfüggő).



Ne használja gyúlékony folyadékok vagy gázok környezetében.



Automatikus indítás



Ne használja nedves környezetben.



A készüléket nem gyermekek általi használatra tervezték (a termék nem játék).



Ne érjen hozzá kézzel a papíradagolóhoz.



Ne érjen hozzá a ruhájával a papíradagolóhoz.



Ne érintse haját a papíradagolóhoz.



Tartsa távol a szóróflakonokat.



Az iratok megsemmisítése előtt távolítsa el belőlük a tűzőkapcsokat és gemkapcsokat.



Ne helyezzen be lemezeket.



CD/DVD lemezek megsemmisítésekor védőszemüveget kell viselni!



A karbantartás előtt válassza le az iratmegsemmisítőt az elektromos hálózatról.



Műszaki adatok – A műszaki változtatások jogát fenntartjuk.



Zajszint üresjáratban



Behúzási sebesség



Papír – keresztvágás



CD/DVD – keresztvágás



Kártyák – keresztvágás



Tömeg



A hálózati dugó az áramellátás leválasztására szolgál.



A dugaszoló aljzat legyen a készülék közelében, könnyen elérhető helyen!



Kezelés



Az iratmegsemmisítő használatra kész



Az iratmegsemmisítő működik



Automatikus kikapcsolás!



Az iratmegsemmisítő hosszú használat és/vagy túlterhelés miatt automatikusan leáll, hogy lehűlhessen.



Karbantartási utasítások/hibaelhárítás



Megtelt a tartály



Lehetséges problémák



Automatikus kikapcsolás nyitott fedélnél

**ВНИМАНИЕ!**

ПЕРЕД вводом в эксплуатацию машины для уничтожения деловых бумаг внимательно прочитайте руководство по эксплуатации и указания по технике безопасности.

Строго придерживайтесь указаний!

Сохраните руководство по эксплуатации для использования в будущем.

**Оглавление**

1	Важная информация	46
1.1	Применение по назначению, гарантийные обязательства	46
1.2	Указания по технике безопасности	47
1.3	Объяснение пиктограмм	48
1.4	Комплект поставки	88
1.5	Технические характеристики	88
2	Работа с устройством	89
2.2	Подключение устройства к электросети	89
2.3	Включение устройства	89
2.4	Уничтожение бумаг	90
2.10	Режим непрерывной работы	92
2.11	Блокировка	93
2.14	Уничтожение CD/DVD-дисков и пластиковых карт	94
3	Техническое обслуживание и устранение неисправностей	96
3.1	Удаление разрезанного материала	96
3.3	Емкость/крышка открыта	96
3.4	Перегрев	97
3.5	Ручная подача при образовании затора	97
3.7	Автоматическая подача при образовании затора	98
3.10	Заблокированная автоматическая подача при образовании затора	99
3.13	Аварийная разблокировка без ключа	100
3.17	Очистка устройства	101

1.1 Применение по назначению, гарантийные обязательства

Этот аппарат предназначен для уничтожения деловых бумаг.

В зависимости от модели аппарат может также уничтожать небольшое количество следующих материалов:

- CD-/DVD-диски, чековые и кредитные карточки (см. раздел «Технические характеристики»);
- скобы и скрепки, используемые для скрепления обычной документации (исключение: оборудование с уровнем секретности P6 и P7).

Устройство снабжено механизмом автоматической подачи стопок листов бумаги, состоящих из несложных отдельных листов (макс. плотность 100 г/м²). Как правило, бумага, шитая скрепками или скобами, тоже может обрабатываться. Необходимое условие для этого — расположение скоб на задней стороне лотка для бумаги (отдаленной от пользователя). Тем не менее, для продления срока службы устройства все скрепки и скобы перед уничтожением рекомендуется снять. В отдельных случаях, в зависимости от количества и положения скоб, а также от объема скрепленных скобами стопок листов, это может привести к неправильной подаче и, соответственно, к прерыванию процесса уничтожения.

Гарантийные обязательства не распространяются на износ и повреждения, вызванные ненадлежащим использованием устройства или вмешательством третьих лиц.

Машина для уничтожения бумаг предназначена для домашнего пользования и для офисов с небольшим документооборотом.

Для указанной в технических характеристиках производительности (в листах бумаги) действуют следующие общие условия:

Максимальное количество листов, которое можно разрезать за один цикл при следующих условиях: новые или смазанные маслом режущие валы, холодный мотор, питание от сети с номинальными напряжением



1.2 Указания по технике безопасности

и частотой (230 В/50 Гц; 120 В/60 Гц). Отклонения могут привести к снижению производительности (в листах бумаги) и повышению шума во время работы.

Листы подаются по центру в продольном направлении под углом 90°. Производительность зависит от свойств бумаги и способа подачи.

- Указания по технике безопасности
- Не устанавливать машину вблизи источников тепла!
- Машину следует хранить, транспортировать и использовать только в вертикальном положении!
- Возле машины использовать только жидкости и газы, соответствующие директивам компании DAHLE!
- Открывать машину запрещено!
- Использовать аппарат только в закрытых помещениях при температуре от 10 до 25 °C (от 50 до 77 °F) и влажности воздуха, не способствующей образованию конденсата (от 15 до 95 %)!
- Обеспечить защиту проводки здания от коротких замыканий: макс. 16 А (в США — макс. 20 А).
- Не допускать работы машины на холостом ходу!
- Аппарат не предназначен для использования лицами (включая детей) с ограниченными физическими, сенсорными или умственными способностями, а также лицами, не обладающими надлежащим опытом и знаниями, за исключением случаев, когда они работают под присмотром или получили инструкции по эксплуатации аппарата от лица, ответственного за безопасность.



Утилизировать машину для уничтожения бумаг с учетом требований по охране окружающей среды, сдав ее в специализированный пункт сбора отходов. Не выбрасывать детали машины для уничтожения бумаг или компоненты упаковки вместе с бытовыми отходами.



1.3 Объяснение пиктограмм



Важная информация



Прочитать информацию для пользователя/
указания по технике безопасности



ВНИМАНИЕ



Не использовать вблизи едких веществ.



Установить машину устойчиво на полу на расстоянии 100 мм от стены, не допускать образования теплового застоя, активировать стопор (в зависимости от типа)



Не использовать рядом с воспламеняющимися жидкостями или газами.



Автоматический запуск



Не подвергать воздействию влаги



Данная машина для уничтожения бумаг не предназначена для использования детьми (изделие не является игрушкой).



Не прикасаться руками к механизму подачи бумаги.



Не допускать контакта одежды с механизмом подачи бумаги!



Не допускать контакта волос с механизмом подачи бумаги!



Не хранить вблизи машины аэрозольные баллончики!



Перед процессом уничтожения снять с бумаги все скрепки и скобы!



Не использовать для уничтожения дискет!



При уничтожении CD/DVD-диска следует носить защитные очки!



Перед проведением работ по техническому обслуживанию отключить машину от электропитания!



Технические характеристики – Возможны технические изменения!



Уровень рабочего шума на холостом ходу



Скорость подачи



Перекрестная резка бумаги



Перекрестная резка CD/DVD-дисков



Перекрестная резка пластиковых карт



Масса



Сетевой штекер используется для отсоединения от электросети.



Необходимо обеспечить близость и быстрый доступ устройства к розетке!



Работа с машиной



Машина для уничтожения деловых бумаг в состоянии готовности



Машина для уничтожения деловых бумаг в рабочем состоянии



Автоматическое выключение!



При длительной эксплуатации и/или перегрузке машина для уничтожения бумаг автоматически отключается для остывания.



Указания по техническому обслуживанию/устранение неисправностей



Емкость заполнена



Возможные неисправности



автоматическое отключение при открывании корпуса

et Juhised



TÄHELEPANU!

Lugege kasutusjuhend ja ohutusjuhised tähelepanelikult ENNE paberipurustaja kasutamist läbi.



Juhistest tuleb kinni pidada!
Hoidke kasutusjuhend hilisemaks kasutamiseks alles.

Sisukord

1	Tähtis teave	49
1.1	Sihtotstarbeline kasutamine, garantii.	49
1.2	Ohutusjuhised.	50
1.3	Piktogrammide legend	50
1.4	Pakendi sisu	88
1.5	Tehnilised andmed	88
2	Käsitsemine	89
2.2	Seadme ühendamine vooluvõrku	89
2.3	Seadme sisselülitamine	89
2.4	Paberi purustamine	90
2.10	Püsirežiim	92
2.11	Lukustamine	93
2.14	CD-/DVD-plaatide ja kaartide purustamine	94
3	Hooldus/tõrgete kõrvaldamine	96
3.1	Purustatud materjali kõrvaldamine.	96
3.3	Mahuti/kaas avatud.	96
3.4	Ülekuumenemine.	97
3.5	Manuaalse sissetõmbe paberiummistus.	97
3.7	Automaatse sissetõmbe paberiummistus.	98
3.10	Paberiummistus lukustatud automaatse sissetõmbes	99
3.13	Hädaolukorras luku avamine võtmeta.	100
3.17	Seadme puhastamine	101

1.1 Sihtotstarbeline kasutamine, garantii

Paberipurustaja on mõeldud paberi purustamiseks. Olenevalt mudelist võib väheses koguses purustada ka järgmisi materjale:

- CD-/DVD-plaadid, panga- ja krediitkaardid (vt Tehnilised andmed).
- paberdokumentides tavalisel kasutusmääral olevad klambrid ja kirjaklambrid (väljaarvatud P6 ja P7 ohutustaseme seadmed).

Seadmel on automaatne sissetõmme lehevirna jaoks, mis koosneb voltimata üksikutest lehtedest (max 100 g/m²). Köitmis- ja kirjaklambritega paberit võib üldjuhul samuti töödelda. See eeldab, et klambrid oleksid seatud paberisahtli tagumise külje poole (kasutajast kaugemal). Seadme kasutusea pikendamiseks soovitage siiski köitmis- ja kirjaklambrid enne purustamist eemaldada. Erijuhul, sõltuvalt klambrite kogusest ja asendist, samuti klambritega paberivirna suuruselt, võib sissetõmbamisel esineda vigu ja seega võib ka purustamine katkeda.

Kulumisest, mittesihtotstarbelisest kasutamisest ja ka kolmandate isikute tehtud parandustöödest põhjustatud kahjud ei kuulu garantii ega tootevastutuse alla.

Paberipurustaja on mõeldud kasutamiseks erasfääris ja tavapärasel bürookeskkonnas.

Tehnilistes andmetes esitatud lehe lõikamise võimsusele kehtivad alljärgnevad raamtingimused.

Maksimaalne arv lehti, mida ühe töökäiguga saab lõigata, kui tingimused on järgmised: uued, vajaduse korral õlitatud lõikerullikud, külm mootor, vooluvastustus nimipingele ja nimisagedusega (230 V/50 Hz; 120 V/60 Hz). Kõrvalekallete tagajärjeks võib lehtede lõikamise võimsus olla madalam ja müratase suurem.

Lehed tuleb sisestada keskelt ja pikuti 90° nurga all. Ka paberi omadused ja sisestamise viis mõjutavad lehe lõikamise võimsust.



1.2 Ohutusjuhised

- Seadet ei tohi paigutada soojusallika lähedusse!
- Seadet tohib ainult püstises asendis ladustada, transportida ja käitada!
- Kasutage seadmes ainult DAHLE nõuetele vastavaid vedelikke ja gaase!
- Seadet ei tohi avada!
- Seadet tohib kasutada vaid suletud ruumides, mille temperatuur jääb vahemikku 10 °C kuni 25 °C (50 °F kuni 77 °F) ja mittekontendenseeruv õhuniiskus vahemikku 15 % kuni 95 %.
- Tagage hoone paigalduse lühisekindlus max 16 A (US max 20 A).
- Seadet ei tohi tühjalt käitada!
- Seade pole mõeldud kasutamiseks piiratud füüsiliste, sensorsete või vaimsete võimetega isikute poolt (sh lapsed) või väheste kogemuste ja teadmistega, välja arvatud juhul, kui neid seadme kasutamisel juhendatakse või antakse üksikasjalikud juhised ohutuse eest vastutava isiku poolt.



Viige kõrvaldamisele kuuluv dokumendipurustaja ettenähtud korras ja keskkonnanahoidlikult heakskiidetud kogumiskohata. Ärge visake paberipurustaja osi ega pakendit tavalisse olmeprügisse.

1.3 Piktogrammide legend



Oluline teave



Lugege kasutusteavet/ohutusmärkusi



TÄHELEPANU



Ärge kasutage seadet happeliste ainete läheduses.



Paigutage seade seinast 100 mm kaugusele põrandale seisma, tagage sooja õhu äravool. Rakendage seisupidurit (olenevalt mudelist)



Ärge kasutage seadet põlemisohtlike ainete või gaaside läheduses.



Automaatne käivitumine



Ärge jätke niiskesse keskkonda



Dokumendipurustaja ei sobi lastele kasutamiseks (toode pole mänguasi).



Ärge puudutage paberi sisestusava kätega!



Ärge puudutage paberi sisestusava riietega!



Ärge puudutage paberi sisestusava juustega!



Hoidke aerosoolpurgid eemal!



Enne purustamist eemaldage kirja- ja vihikulambri!



Ärge sisestage seadmesse diskette!



CD või DVD hävitamisel tuleb kanda kaitseprille!



Enne hooldustöid lahutage paberipurustaja vooluvõrgust!



Tehnilised andmed –tootjal on õigus teha tehnilisi muudatusi!



Müratase seadme tühikäigu puhul



Etteandekiirus



Paberi peenestamine



CD-/DVD-plaatide peenestamine



Kaartide peenestamine



Kaal



Seadme saab vooluvõrgust eraldada pistiku abil.



Pistikupesa peab asuma seadme lähedal ja olema kergesti ligipääsetav!



Käsitsemine



Paberipurustaja on kasutusvalmis



Paberipurustaja töötab



Automaatne väljalülitus!



Pikemaajalise kasutamise ja/või ülekoormuse puhul lülitub dokumendipurustaja jahtumiseks automaatselt välja.



Hooldusjuhised / tõrgete kõrvaldamine



Mahuti on täis



Võimalikud tõrked



automaatne väljalülitamine avatud korpuse puhul



lt Naudojimo instrukcija



DĖMESIO!

Prieš pradėdami naudoti dokumentų smulkintuvą atidžiai perskaitykite naudojimo instrukciją ir saugos instrukcijas.

Būtina vadovautis instrukcijomis! Saugokite instrukcijas, kad paskaitytumėte ir vėliau.



Turinys

1	Svarbi informacija	52
1.1	Naudojimas pagal paskirtį, garantija	52
1.2	Saugos nurodymai	53
1.3	Piktogramos legenda	54
1.4	Komplektacija	88
1.5	Techniniai duomenys	88
2	Valdymas	89
2.2	Prietaiso įjungimas į elektros tinklą	89
2.3	Prietaiso išjungimas	89
2.4	Popieriaus smulkinimas	90
2.10	Nuolatinės priekinės eigos režimas	92
2.11	Blokuotė	93
2.14	CD / DVD, kortelių naikinimas	94
3	Techninė priežiūra / trikčių šalinimas	96
3.1	Nuokarpų pašalinimas	96
3.3	Atidaryta dėžė / dangtis	96
3.4	Perkaitimas	97
3.5	Susigrūdęs popierius tiekiant rankiniu būdu	97
3.7	Susigrūdęs popierius tiekiant automatinio būdu	98
3.10	Susigrūdęs popierius tiekiant automatinio būdu esant įjungtai blokuotei	99
3.13	Atblokavimas be rakto	100
3.17	Prietaiso valymas	101

1.1 Naudojimas pagal paskirtį ir garantija

Dokumentų naikiklis skirtas popieriu naikinti.

Be to, priklausomai nuo modelio varianto, galima naikinti nedidelius toliau nurodytų medžiagų kiekius:

- CD ir DVD diskus, debetines ir kreditines korteles (žiūrėkite skyrių „Techniniai duomenys“).
- popieriniuose dokumentuose esančias sąsagėles bei kanceliarines sąvaržėles, jei jų kiekis neviršija įprastai naudojamo (išimtis: P6 ir P7 saugumo klasių prietaisai).

Prietaisas turi automatinio tiekimo įtaisą, į kurį galima dėti popierių šūsnis, sudarytas iš pavienių nesulankstytų lapų (maks. 100 g/m²). Tiek sąvaržėlėmis, tiek sąsagėlėmis susegtą popierių paprastai taip pat galima kartu perdirbti. Tik reikia laikytis sąlygos, kad sąvaržėlės ir sąsagėlės turi būti popieriaus dėklo galinėje pusėje (nukreiptos nuo naudotojo). Tačiau siekiant pratęsti prietaiso eksploatavimo trukmę rekomenduojama prieš naikinant dokumentus nuimti sąvaržėles / sąsagėles. Kai kuriais atvejais, priklausomai nuo sąvaržėlių / sąsagėlių kiekio ir padėties bei susegtų popierių šūsnyje kiekio, popierius gali būti netinkamai įtraukiamas, dėl ko gali nutrūkti naikinimo procesas.

Gedimams, atsiradusiems dėl susidėvėjimo, netinkamo naudojimo ar dėl trečiųjų šalių atliktų intervencijų, netaikomi nei įstatymų numatyti garantiniai įsipareigojimai, nei gamintojo savanoriškai suteikiama garantija.

Dokumentų naikiklio konstrukcija yra pritaikyta naudoti buityje ir įprastinėje biuro aplinkoje.

Lapų apdorojimo našumui, nurodytam techniniuose duomenyse, galioja tokios pagrindinės sąlygos:

Maksimalus lapų skaičius, kurie vienos eigos metu įjauštomi tokiomis sąlygomis: Nauji, jeigu reikia, patepti įjauštymo velenėliai, šaltas variklis, maitinimo vardinė įtampa ir vardinis dažnis (230 V / 50 Hz; 120 V / 60 Hz). Nukrypstant nuo šių sąlygų lapų apdorojimo našumas gali būti mažesnis, o triukšmas veikiant prietaisui didesnis.



1.2 Saugos nurodymai

Lapai tiekiami per vidurį ir išilgai, 90° kampu. Priklausomai į popieriaus savybių ir tiekimo, lapų apdorojimo našumas taip pat gali skirtis.

- Dokumentų smulkintuvo negalima statyti prie šilumos šaltinio!
- Įrenginį laikyti, gabenti ir naudoti leidžiama tik stačią!
- Su įrenginiu leidžiama naudoti tik tuos skysčius ir dujas, kurie atitinka DAHLE taikytinas direktyvas!
- Įrenginio negalima atidaryti!
- Saugant pastato elektros tinklą nuo trumpųjų jungimų turi būti įrengtas maks. 16 A saugiklis (JAV maks. 20 A).
- Prietaisą leidžiama naudoti tik uždaroje patalpose, esant 10–25 °C (50–77 °F) temperatūrai ir 15–95 % oro drėgnei be kondensacijos!
- Nenaudokite tuščio įrenginio!
- Prietaisas nėra skirtas naudoti asmenims (įskaitant ir vaikus), kurių fiziniai, jutiminiai ar protiniai gebėjimai yra riboti, arba kuriems trūksta patyrimo ir žinių, išskyrus atvejus, kai jie dirba prižiūrimi arba už saugą atsakingas asmuo juos išsamiai instruktuoja, kaip naudotis prietaisu.



Dokumentų smulkintuvą utilizuokite techniniu požiūriu tinkamu ir aplinkai nekenksmingu būdu, t. y. atiduokite jį įgaliojamai atliekų tvarkymo įmonei. Dokumentų smulkintuvo dalių ir pakuotės neišmeskite su buitinėmis atliekomis.

1.3 Piktogramos legenda

-  Svarbi informacija
-  Skaityti naudotojo informaciją/saugos instrukcijas
-  DĖMESIO
-  Draudžiama naudoti aparatą šalia edžių medžiagų.
-  Įrenginį reikia stabiliai pastatyti ant grindų 100 mm atstumu nuo sienos, saugoti nuo įkaitimo pavojaus, įjungti stabdymo mechanizmą (priklauso nuo įrenginio tipo).
-  Nenaudoti netoli degių skysčių arba dujų.
-  Automatinis įjungimas
-  Statykite tik ant sauso pagrindo
-  Šis dokumentų smulkintuvas neskirtas naudotis vaikams (gaminys nėra žaistas).
-  Nelieskite popieriaus tiektuvo rankomis.
-  Nekiškite prie popieriaus tiektuvo drabužių!
-  Nekiškite prie popieriaus tiektuvo plaukų!
-  Nelaikykite arti aerozolių!
-  Prieš naikindami dokumentus pašalinkite sąvaržėles ir sąsagėles!
-  Negalima naikinti diskelių!
-  Prieš naikindami DVD / kompaktinius diskus užsidėkite apsauginius akinius!
-  Prieš atlikdami priežiūros darbus dokumentų smulkintuvą atjunkite nuo maitinimo šaltinio!

-  Techniniai duomenys - Galimi techniniai pakeitimai!
-  Triukšmo lygis tuščiaja eiga
-  Įtraukimo greitis
-  Popieriaus smulkinimas skiautėmis
-  CD/DVD smulkinimas skiautėmis
-  Kortelių smulkinimas skiautėmis
-  Masė
-  Tinklo kištukas skirtas elektros maitinimo šaltiniui atjungti!
-  Kištukinis lizdas turi būti lengvai prieinamoje vietoje šalia prietaiso!
-  Valdymas
-  Įrenginys parengtas veikti
-  Įrenginys naudojimo metu
-  Automatinis išjungimas!
-  Ilgo naudojimo ir (arba) perkrovos atveju dokumentų smulkintuvas išsijungia automatiškai, kad atvėstų.
-  Techninės priežiūros / gedimų šalinimo instrukcijos
-  Prisip. dėžė
-  Galimos triktys
-  Automatinis išjungimas, kai atidarytas dangtis

lv Lietošanas norādījumi



UZMANĪBU!

Pirms sākat izmantot dokumentu smalcinātāju, lūdzam uzmanīgi izlasīt lietošanas pamācību un drošības norādes! Ievērojiet drošības norādes! Saglabājiet lietošanas pamācību turpmākai uzziņai.

1.1 Paredzētais pielietojums un garantija

Dokumentu smalcinātājs ir paredzēts papīra sasmalcināšanai.

Daži ierīces modeļi var sasmalcināt arī nelielu tālāk norādīto materiālu daudzumu:

- CD/DVD, maksājumu kartes (skatiet sadaļu "Tehniskie dati");
- papīra dokumentos parastajā daudzumā ietvertās saspaušanas un skavas (izņēmums: ierīces, kas atbilst drošības pakāpei P6 un P7).

Satura rādītājs

1	Svarīga informācija	55
1.1	Paredzētais pielietojums un garantija	55
1.2	Drošības norādes	56
1.3	Paskaidrojumi par piktogrammām	57
1.4	Piegādes komplekts	88
1.5	Tehniskie dati	88
2	Lietošana	89
2.2	Ierīces pievienošana strāvas tīklam	89
2.3	Ierīces ieslēgšana	89
2.4	Dokumentu smalcināšana	90
2.10	Ilgstoša darbība	92
2.11	Blokēšana	93
2.14	CD/DVD un karšu smalcināšana	94
3	Apkope/traucējumu novēršana	96
3.1	Sasmalcinātās masas iztukšošana	96
3.3	Tvertne/vāks atvērts	96
3.4	Pārkaršana	97
3.5	Manuālās ievilkšanas papīra sastrēgums ...	97
3.7	Automātiskās ievilkšanas papīra sastrēgums	98
3.10	Aizvērtas automātiskās ievilkšanas papīra sastrēgums	99
3.13	Avārijas atbloķēšana bez atslēgas	100
3.17	Ierīces tīrīšana	101

ierīce ir aprīkota ar automātisku lapu krautnes ievilkšanu, kas ieviel nesalocītas atsevišķas lapas (maks. 100 g/m²). Ierīce apstrādā arī saskavotu papīru, kas ir sastiprināts ar biroja vai stiprināšanas skavām.

Šādā gadījumā skavām jāatrodas papīra nodalījuma aizmugurē (prom no lietotāja). Taču, lai paildzinātu iekārtas darbību, biroja un stiprinājuma skavas pirms smalcināšanas ieteicams izņemt. Atsevišķos gadījumos atkarībā no saspaužu daudzuma, pozīcijas un papīra krautnes lieluma var notikt nepareiza ievilkšana un sasmalcināšanas process var apstāties.

Garantija neietver nodilumu, kā arī neprofesionālas lietošanas un trešās puses veiktu darbību dēļ radītus ierīces bojājumus.

Dokumentu smalcinātājs ir paredzēts lietošanai nekomerciālos nolūkos un standarta biroja vidē. Uz tehniskajos datos norādīto lapu skaitu attiecas turpmākie robežnosacījumi:

Maksimālais lapu skaits, kas tiek sagrieztas vienā reizē ar šādiem nosacījumiem: jauni un nepieciešamības gadījumā ieeļļoti griešanas veltņi, auksts motors, nomināls barošanas spriegums un frekvence (230 V/50 Hz; 120 V/60 Hz). Novirzes var samazināt apstrādāto lapu skaitu un palielināt ekspluatācijas trokšņus.



Lapas tiek padotas centrēti un gareniski 90° leņķī. Apstrādāto lapu skaits var mainīties atkarībā no papīra īpašībām un padeves veida.















1.2 Drošības norādes

- Ierīci nedrīkst uzstādīt karstuma avota tuvumā!
- Ierīce ir jāglabā, jāpārvadā un jāizmanto tikai vertikālā stāvoklī!
- Ierīcē drīkst izmantot tikai tādus šķidrumus un gāzes, kas atbilst DAHLE vadlīnijām!
- Ierīci nedrīkst atvērt!
- Ēkas elektroinstalācija ir jānodrošina pret īsslēgumu: maks. 16 A (ASV maks. 20 A)!
- Ierīci drīkst izmantot tikai slēgtā telpā, kur gaisa temperatūra ir no 10 °C līdz 25 °C (no 50 °F līdz 77 °F) un kur gaisa mitrums no 15 % līdz 95 % neizraisa ūdens kondensāciju!
- Nepieļaujiet ierīces darbību tukšgaitā!
- Ierīci nedrīkst lietot personas (tostarp bērni) ar ierobežotām fiziskām, sensorām vai garīgām spējām vai nepietiekamu pieredzi un zināšanām, izņemot gadījumus, kad darbs tiek uzraudzīts vai par drošību atbildīgā persona ir veikusi visaptverošu apmācību par ierīces lietošanu.



Dokumentu smalcinātāju utilizējiet pareizā veidā – nododiet to apstiprinātā savākšanas punktā. Neizmetiet dokumentu smalcinātāja daļas vai tā iepakojumu kopā ar sadzīves atkritumiem.

1.3 Paskaidrojumi par pictogrammām

-  Svarīga informācija
-  Izlasīt paziņojumu lietotājam/drošības norādes
-  **UZMANĪBU!**
-  Ierīces tuvumā nedrīkst atrasties kodīgas vielas.
-  Stabili uzstādīt ierīci uz grīdas 100 mm attālumā no sienas, nepieļaut siltuma uzkrāšanos ap ierīci, iedarbināt fiksēšanas mehānismu (atkarībā no ierīces veida)
-  Neizmantot vidē, kur tuvumā ir viegli uzliesmojoši šķidrums un gāzes.
-  Automātiska darbības uzsākšana
-  Sargāt no mitruma
-  Dokumentu smalcinātāju aizliegts lietot bērnēm (ši ierīce nav rotaļlieta)!
-  Aizliegts ar rokām pieskarties papīra padeves vadotnei.
-  Nedrīkst pieļaut apgērba nonākšanu papīra padeves vadotnē!
-  Nedrīkst pieļaut matu nonākšanu papīra padeves vadotnē!
-  Sargāt no aerosoliem!
-  Pirms smalcināšanas izņemiet no dokumentiem skavas un noņemiet saspraudes!
-  Aizliegts smalcināt datora disketes!
-  Iznīcinot CD/DVD, ir jālieto aizsargbrilles!
-  Pirms smalcinātāja apkopes darbu sākuma atvienojiet ierīci no elektriskā tīkla!

-  Tehniskie rādītāji - iespējamas tehniskas izmaiņas!
-  Darbības troksnis tukšgaitā
-  Ievilkšanas ātrums
-  Papīra smalcināšana gabalos
-  CD/DVD smalcināšana gabalos
-  Karšu smalcināšana gabalos
-  Svars
-  Tīkla kontaktspraudnis kalpo kā elektriskās strāvas padeves pārtraukšanas ierīce.
-  Kontaktilgzdai jāatrodas ierīces tuvumā un jābūt viegli pieejamai!
-  Apkalpošana
-  Dokumentu smalcinātājs gatavs darbam
-  Dokumentu smalcinātājs darbojas
-  Automātiska izslēgšana!
-  Ilgākas darbināšanas vai pārslodzes gadījumā dokumentu smalcinātājs automātiski izslēdzas, lai atdzistu.
-  Apkopes norādījumi / darbības traucējumu novēršana
-  Tvertne pilna
-  Iespējamie traucējumi
-  automātiski izslēdzas, kad atver korpusu



CS Návod k použití



UPOZORNĚNÍ!

Návod k obsluze a bezpečnostní pokyny ke skartovacímu zařízení si pozorně pročtěte PŘED jeho uvedením do provozu.

Dodržujte uvedené pokyny!

Návod k obsluze uchovejte pro případ pozdější potřeby.



1.1 Účelové použití, ručení

Skartovací zařízení je určeno ke skartování papíru. V závislosti na modelu je však možné skartovat také malá množství následujících materiálů:

- CD/DVD disky, šekové a kreditní karty (viz technické údaje).
- kancelářské sponky a drátky, které se nacházejí v papírových dokumentech v běžném množství (výjimka: zařízení bezpečnostního stupně P6 a P7).

Obsah

1	Důležité informace	58
1.1	Účelové použití, ručení	58
1.2	Bezpečnostní ustanovení	59
1.3	Popis piktogramů	60
1.4	Rozsah dodávky	88
1.5	Technické údaje	88
2	Obsluha	89
2.2	Připojení přístroje k elektrické síti	89
2.3	Zapnutí přístroje	89
2.4	Skartování papíru	90
2.10	Trvalý chod vpřed	92
2.11	Zablokování	93
2.14	Skartování CD/DVD a karet	94
3	Údržba / odstraňování závad	96
3.1	Vyprázdnění rozřezaného materiálu	96
3.3	Otevřený zásobník / otevřené víko	96
3.4	Přehřátí	97
3.5	Uvznutý papír v ručním podávání	97
3.7	Uvznutý papír v automatickém vtahování	98
3.10	Uvznutý papír v zablokovaném automatickém vtahování	99
3.13	Nouzové odblokování bez klíče	100
3.17	Vyčistěte přístroj	101

Přístroj je vybaven automatickým vtahováním stohu papíru, který obsahuje nepřehnuté jednotlivé listy (max. 100g/m²). Papír sepnutý kancelářskými sponkami nebo sešitý sešivacími svorkami lze obvykle zpracovat také. Předpokladem je uspořádání sponek a svorek na zadní straně přihrádky na papíry (strana vzdálenější od uživatele). K prodloužení životnosti přístroje se však doporučuje odstranit kancelářské sponky a sešivací svorky ještě před skartací. V jednotlivých případech a v závislosti na množství a poloze sponek a také na rozsahu sepnuté hromádky papírů může dojít k chybě při vtahování, a tím k přerušení procesu skartace.

Na opotřebení, poškození způsobené nevhodným používáním, stejně jako zásahy třetí stranou se nevztahuje ručení ani záruka.

Skartovač je koncipován k provozu v soukromém sektoru a v běžném kancelářském prostředí. Kapacita skartace uvedená v technických údajích podléhá následujícím podmínkám: Maximální počet současně skartovaných listů za následujících podmínek: Nové případně naolejované řezací válce, studený motor, elektrické napájení při jmenovitých hodnotách napětí a frekvence (230 V/50 Hz, 120 V/60 Hz). Odchytky mohou vést ke snížení kapacity skartace a ke zvýšenému hluku.



1.2 Bezpečnostní ustanovení

Listy se vkládají doprostřed a podélně pod úhlem 90°. V závislosti na vlastnostech a podávání papíru se kapacita skartace může také lišit.

- Zařízení neumísťujte do blízkosti zdrojů tepla!
- Zařízení skladujte, přepravujte a provozujte pouze v poloze ve stoje.
- Na zařízení používejte pouze kapaliny a plyny odpovídající směrnícím společnosti DAHLE.
- Zařízení nikdy neotvírejte!
- Zajistěte ochranu instalace v budově proti zkratu: max. 16 A (USA max. 20 A).
- Provozujte zařízení výhradně v uzavřených místnostech při teplotě 10 °C až 25 °C (50 °F až 77 °F) a při nekondenzující vlhkosti vzduchu od 15 % do 95 %!
- Zařízení nenechávejte běžet naprázdno!
- Zařízení není určeno k používání osobami (včetně dětí) s omezenými fyzickými, smyslovými nebo duševními schopnostmi nebo s nedostatečnými zkušenostmi a znalostmi, pokud nepracují pod dohledem nebo pokud se jim nedostane podrobného návodu k používání přístroje od osoby odpovědné za bezpečnost.



Skartovací zařízení nechte ekologicky a odborně zlikvidovat autorizovanou sběrnou. Nevyhazujte žádné díly skartovače nebo balení do domácího odpadu.



1.3 Popis piktoqramů



Důležitá informace



Přečtěte si informace pro uživatele/bezpečnostní pokyny



POZOR



Nepoužívejte zařízení v blízkosti žíravých látek.



Zařízení umístěte stabilně na podlahu s odstupem 100 mm ode zdi, tím zabráníte kumulaci tepla, zablokujte brzdy na kolečkách (podle typu zařízení)



Nepoužívejte zařízení v blízkosti hořlavých kapalin nebo plynů.



Automatický rozběh



Nepoužívejte ve vlhkém prostředí



Toto skartovací zařízení není určeno pro děti (tento produkt není hračka).



Otvoru pro vstup papíru se nedotýkejte rukama.



Zabraňte styku přívodu papíru s oblečením!



Pozor, aby se do vstupu pro papír nedostaly vlasy!



Uchovávejte spreje z dosahu přístroje!



Kancelářské sponky a sponky ze sešivaček před skartováním odstranit!



Nevkládejte žádné disky!



Skartujte CD/DVD pouze s nasazenými ochrannými brýlemi!



Před prováděním údržby skartovač odpojit od přívodu proudu!



Technické údaje — Technické změny vyhrazeny!



Provozní hlučnost při chodu naprázdno



Rychlost vtahování



Řezání papíru na kusy



Řezání CD/DVD na kusy



Řezání karet na kusy



Hmotnost



Síťová zástrčka slouží jako dělicí zařízení od napájení ze sítě.



Zásuvka by měla být upevněna v blízkosti zařízení a snadno přístupná!



Obsluha



Skartovač v provozní pohotovosti



Skartovač v provozu



Automatické vypínání!



Při delším provozu a/nebo při přetížení se skartovací zařízení automaticky vypne, dokud nevychladne.



Pokyny pro údržbu/odstraňování závad



Zásobník plný



Možné poruchy



automatické vypnutí při otevření krytu

**sk** **Návod na použitie****POZOR!**

PRED uvedením skartovacieho prístroja do prevádzky si pozorne prečítajte návod na obsluhu a bezpečnostné pokyny.

Pokyny sa musia aplikovať!



Návod na obsluhu si uschovajte na neskoršie použitie.

Obsah

1	Dôležité informácie.....	61
1.1	Použitie v súlade s určeným účelom, záruka.....	61
1.2	Bezpečnostné pokyny.....	62
1.3	Legenda piktogramov.....	63
1.4	Rozsah dodávky.....	88
1.5	Technické údaje.....	88
2	Obsluha.....	89
2.2	Pripojenie zariadenia k elektrickej sieti.....	89
2.3	Zapnutie prístroja.....	89
2.4	Skartácia papiera.....	90
2.10	Trvalý chod vpred.....	92
2.11	Blokovanie.....	93
2.14	Skartácia CD/DVD, kariet.....	94
3	Údržba / odstraňovanie porúch.....	96
3.1	Odstránenie skartovaného materiálu.....	96
3.3	Otvorená nádrž / otvorený poklop.....	96
3.4	Prehriatie.....	97
3.5	Zaseknutie papiera pri ručnom vkladaní... ..	97
3.7	Zaseknutie papiera pri automatickom vťahovaní.....	98
3.10	Zaseknutie papiera pri blokovanom automatickom vťahovaní.....	99
3.13	Núdzové odblokovanie bez kľúča.....	100
3.17	Čistenie prístroja.....	101

1.1 **Použitie v súlade s určeným účelom, záruka**

Skartovací prístroj je určený na skartovanie papiera. Podľa variantu modelu je možné okrem toho skartovať malé množstvá nasledujúcich materiálov:

- CD/DVD disky, šekové a kreditné karty (pozri technické údaje).
- spinky a kancelárske spony nachádzajúce sa v papierových dokumentoch, v obvykle používanom rozsahu (výnimka: prístroje stupňa bezpečnosti P6 a P7).

Prístroj je vybavený automatickým vťahovaním zväzkov listov, ktoré pozostávajú z neprehnutých listov (max. 100g/m²). Papier zošíty kancelárskymi spinkami alebo spojený sponami môže byť spravidla tiež skartovaný. Predpokladom je, aby sa spinky nachádzali na zadnej strane papierového zväzku (na vzdialenejšej strane od používateľa). V záujme predĺženia životnosti prístroja však odporúčame, aby boli kancelárske spinky/spony pred skartáciou odstránené. V ojedinelých prípadoch, v závislosti od množstva a polohy spiniiek, ako aj od veľkosti papierového zväzku môže dôjsť k nesprávnemu vťahnutiu a následne k prerušeniu procesu skartovania.

Ručenie ani záruka sa nevzťahuje na opotrebovanie, škody spôsobené neodborným používaním ani na zásahy tretej strany.

Skartovač je určený na súkromné použitie a na použitie v bežnom kancelárskom prostredí.

Na základe kapacity skartácie uvedenej v technických údajoch platia nasledovné rámcové podmienky:

Maximálny počet listov, ktoré je možné rezať naraz, v prípade dodržania nasledovných podmienok: Nové, resp. naolejované rezacie valce, studený motor, napájací prúd s menovitým napätím a menovitou frekvenciou (230 V/50 Hz, 120 V/60 Hz).



Odchýlky môžu mať za následok zníženie kapacity skartácie a zvýšenie hlučnosti chodu.

Listy sú vedené stredom a po dĺžke pod uhlom 90°. V závislosti od vlastností papiera a prívodu sa môže kapacita skartácie odlišovať.

















1.2 Bezpečnostné pokyny

- Neinštalujte prístroj v blízkosti tepelného zdroja!
- Prístroj skladujte, prepravujte a prevádzkujte iba nastojato!
- Na prístroji používajte iba kvapaliny a plyny, ktoré zodpovedajú smerniciam spoločnosti DAHLE!
- Prístroj sa nesmie otvárať!
- Prístroj neprevádzkujte v chode naprázdno!
- Prístroj prevádzkujte iba v uzavretých priestoroch, pri 10 °C až 25 °C (50°F do 77°F) a nekondenzujúcej vlhkosti vzduchu od 15 % do 95 %!
- Zabezpečte ochranu pred skratom na inštalácii v budove: max. 16 A (US max. 20 A).
- Zavádzače papiera používajte iba jednotlivo!
- Prístroj nie je určený pre používanie osobami (vrátane detí) s obmedzenými fyzickými, zmyslovými alebo duševnými schopnosťami alebo nedostatočnými skúsenosťami a vedomosťami, jedine s výnimkou, ak pri používaní prístroja pracujú pod dozorom alebo výlučným vedením osoby, ktorá zodpovedá za bezpečnosť.



Skartovací prístroj zlikvidujte odborne a ekologicky na autorizovanom zbernom mieste. Žiadne časti skartovacieho prístroja alebo balenia nezhadzujte do domáceho odpadu.

1.3 Legenda piktogramov

-  Dôležitá informácia
-  Prečítajte si informáciu pre používateľa/bezpečnostné pokyny
-  POZOR
-  Nepoužívať v blízkosti žieravých látok.
-  Prístroj stabilne nainštalujte na podlahu a vo vzdialenosti 100 mm od steny, zabráňte hromadeniu tepla, Stlačte ručné brzdy (v závislosti od typu)
-  Nepoužívať v blízkosti horľavých kvapalín alebo plynov.
-  Automatický rozbeh
-  Nevystavujte vlhkosti
-  Tento skartovací prístroj nie je určený na používanie deťmi (výrobok nie je hračka).
-  Otvoru prívodu papiera sa nedotýkajte rukami!
-  Otvoru prívodu papiera sa nedotýkajte oděvom!
-  Otvoru prívodu papiera sa nedotýkajte vlasmi!
-  Do blízkosti neukladajte plechovky so sprejmi!
-  Pred skartovaním odstráňte z dokumentov kancelárske spinky a spony!
-  Nezasúvajte žiadne diskety!
-  Skartuje CD/DVD iba s nasadenými ochrannými okuliarmi!
-  Pred údržbárskymi prácami odpojte skartovací prístroj od napájacieho prúdu!

-  Technické údaje — Technické zmeny vyhradené!
-  Prevádzková hlasitosť pri chode naprázdno
-  Rýchlosť vťahovania
-  Pričný rez papiera
-  Pričný rez CD/DVD
-  Pričný rez karty
-  Hmotnosť
-  Sieťová zástrčka slúži na oddelenie od napájania.
-  Zásuvka musí byť umiestnená v blízkosti prístroja a musí byť ľahko prístupná!
-  Obsluha
-  Skartovací prístroj v pohotovostnom stave
-  Skartovací prístroj v prevádzke
-  Automatické vypnutie!
-  Pri dlhšej prevádzke a/alebo preťažení sa skartovací prístroj automaticky vypne, aby vychladol.
-  Pokyny na údržbu/odstraňovanie porúch
-  Nádoba je plná
-  Možné poruchy
-  automatické vypnutie pri otvorenom kryte

**UWAGA!**

PRZED uruchomieniem niszczarki należy uważnie przeczytać instrukcję obsługi oraz wskazówki bezpieczeństwa.

Należy przestrzegać wskazówek! Instrukcję obsługi należy zachować do późniejszego użytku.

**Spis treści**

1	Ważne informacje	64
1.1	Użytkowanie zgodne z przeznaczeniem, gwarancja	64
1.2	Wskazówki bezpieczeństwa	65
1.3	Objaśnienie symboli	66
1.4	Zakres dostawy	88
1.5	Dane techniczne	88
2	Obsługa	89
2.2	Podłączanie urządzenia do sieci elektrycznej	89
2.3	Włączanie urządzenia	89
2.4	Niszczanie dokumentów	90
2.10	Tryb ciągły	92
2.11	Blokada	93
2.14	Niszczanie CD/DVD i kart	94
3	Konserwacja/usuwanie usterek	96
3.1	Opróżnianie niszczarki	96
3.3	Pojemnik lub pokrywa są otwarte	96
3.4	Przegrzanie	97
3.5	Zator papieru, podajnik ręczny	97
3.7	Zator papieru, podajnik automatyczny	98
3.10	Zator papieru, zablokowany podajnik automatyczny	99
3.13	Odblokowywanie awaryjne bez klucza	100
3.17	Czyszczenie urządzenia	101

1.1 Użytkowanie zgodne z przeznaczeniem, gwarancja

Niszczarka jest przeznaczona do niszczenia papieru. W zależności od modelu niszczarki można ją ponadto wykorzystać do niszczenia w niewielkich ilościach następujących materiałów:

- płyt CD/DVD, kart bankomatowych i kredytowych (patrz dane techniczne).
- występujących w zwykłym zakresie w dokumentach papierowych zszywek i spinaczy biurowych (wyjątek: urządzenia stopnia bezpieczeństwa P6 i P7).

Urządzenie jest wyposażone w automatyczny podajnik stosów arkuszy, które składają się niezłożonych pojedynczych arkuszy (maks. 100 g/m²). Istnieje również możliwość przetwarzania papieru spiętego zarówno spinaczami biurowymi, jak i zszywkami. Warunkiem jest rozmieszczenie spinaczy lub zszywek z tyłu pojemnika na papier (tyłem do użytkownika). Aby wydłużyć żywotność urządzenia, zaleca się jednak usunięcie spinaczy biurowych/zszywek przed zniszczeniem papieru. W indywidualnych przypadkach w zależności od ilości i położenia spinaczy/zszywek oraz wielkości zszytego stosu arkuszy może dojść do zakłóceń podczas podawania i tym samym do przerwania procesu niszczenia.

Zużycie, szkody powstałe na skutek nieprawidłowego użycia oraz ingerencji osób trzecich nie są objęte rękojmią ani gwarancją.

Ta niszczarka dokumentów jest przeznaczona do użytku prywatnego oraz w normalnych warunkach biurowych. Wydajność niszczarki podana w danych technicznych podlega następującym warunkom ogólnym: Maksymalna ilość kartek, która może zostać zniszczona w jednej turze w następujących warunkach: Nowe, ewentualnie naoliwione walce tnące, zimny silnik, zasilanie elektryczne z napięciem znamionowym i częstotliwością znamionową (230V/50Hz; 120V/60Hz). Odstępstwa mogą prowadzić do zmniejszonej wydajności i do głośniejszej pracy.



1.2 Wskazówki bezpieczeństwa

Kartki należy wkładać na środku, wzdłuż, pod kątem 90°. Wydajność może być zmienna również zależnie od rodzaju papieru i sposobu wprowadzania go.

- Urządzenia nie ustawiać w pobliżu źródeł ciepła!
- Urządzenie składować, transportować i użytkować wyłącznie w pozycji pionowej!
- W urządzeniu stosować wyłącznie ciecie i gazy spełniające wytyczne DAHLE!
- Urządzenia nie wolno otwierać!
- Nie użytkować urządzenia na pusto!
- Urządzenie wolno użytkować wyłącznie w zamkniętych pomieszczeniach w temperaturze od 10 °C do 25 °C (50 °F do 77 °F) oraz przy nieskrapającym się powietrzu o wilgotności od 15 % do 95 %!
- Należy zapewnić zabezpieczenie przeciwzwarceniowe w instalacji budynku: maks. 16 A (US maks. 20 A).
- Z podajników korzystać tylko pojedynczo!
- To urządzenie nie jest przeznaczone do użytku przez osoby (wraz dziećmi) z ograniczonymi zdolnościami fizycznymi, sensorycznymi lub umysłowymi lub z brakiem doświadczenia i wiedzą. Chyba, że pracują one pod nadzorem i otrzymują pełne instrukcje odnośnie korzystania z urządzenia od osoby odpowiedzialnej za bezpieczeństwo.



Niszczarkę usunąć w sposób nieszkodliwy dla środowiska przekazując do autoryzowanego punktu zbiórki. Żadnych elementów niszczarki lub jej opakowania nie wolno wyrzucać wraz z odpadami z gospodarstw domowych.



1.3 objaśnienie symboli



Ważne informacje



Przeczytać informacje dla użytkownika/wskaźówki bezpieczeństwa



UWAGA



Urządzenia nie wolno użytkować w pobliżu substancji żrących



Niszczarkę ustawić na stabilnym podłożu w odległości 100 mm od ściany, unikać zatorów cieplnych, uruchomić hamulec postojowy (w zależności od typu)



Urządzenia nie wolno użytkować w pobliżu palnych cieczy lub gazów.



Automatyczny rozruch



Chronić urządzenie przed wilgocią



Z niszczarki nie wolno korzystać dzieciom (produkt nie jest zabawką).



Podajnika papieru nie wolno dotykać rękami!



Podajnika papieru nie wolno dotykać częściami garderoby!



Podajnika papieru nie wolno dotykać włosami



Trzymać z dala puszki ze sprayem!



Spinacze biurowe oraz zszywki usunąć przed przystąpieniem do niszczenia dokumentu!



Nie wkładać dyskietek!



Podczas niszczenia nośników CD/DVD należy nosić okulary ochronne!



Przed przystąpieniem do prac konserwacyjnych odłączyć niszczarkę od zasilania!



Dane techniczne - Zmiany techniczne zastrzeżone!



Głośność pracy na pusto



Prędkość wciągania



Ścinki papieru



Ścinki CD/DVD



Ścinki kart



Ciężar



Wtyczka sieciowa służy do odłączania zasilania.



Gniazdko powinno być umieszczone blisko urządzenia i łatwo dostępne!



Obsługa



Niszczarka gotowa do pracy



Niszczarka pracuje



Automatyczne wyłączenie!



Niszczarka wyłącza się automatycznie po dłuższym czasie pracy i/lub w razie przeciążenia w celu ostygnięcia.



Wskazówki konserwacyjne / Usuwanie usterek



Pełny pojemnik



Możliwe zakłócenia



Automatyczne wyłączenie w przypadku otwarcia obudowy

ro Instrucțiuni de utilizare



ATENȚIE!

Înainte de punerea în funcțiune a distrugătorului de documente, citiți cu atenție instrucțiunile de utilizare și indicațiile privind siguranța!

Normele de siguranță trebuie aplicate! Păstrați instrucțiunile pentru a le putea consulta ulterior.



1.1 Utilizarea conform destinației prevăzute, garanția standard

Distrugătorul de documente este conceput pentru distrugerea hârtiei.

În funcție de model, în afară de hârtie pot fi distruse și alte materiale în cantitate redusă, cum ar fi:

- CD-uri/DVD-uri, cecuri și carduri bancare (consultați secțiunea Date tehnice).
- clemele de capsator și agrafele de birou care se află în documente, în cantitate uzuală (excepție: aparatele din clasa de siguranță P6 și P7).

Cuprins

1	Informații importante	67
1.1	Utilizarea conform destinației prevăzute, garanția standard.....	67
1.2	Indicații privind siguranța.....	68
1.3	Legenda pictogramelor.....	69
1.4	Pachetul de livrare.....	88
1.5	Date tehnice	88
2	Utilizare	89
2.2	Conectați dispozitivul la rețeaua de curent.....	89
2.3	Cuplați dispozitivul	89
2.4	Distrugerea hârtiei	90
2.10	Mersul înainte continuu	92
2.11	Blocarea	93
2.14	Distrugerea de CD-uri/DVD-uri, carduri	94
3	Întreținerea/remedierea defecțiunilor.....	96
3.1	Evacuarea materialului tocat.....	96
3.3	Decipientului/capacului deschis	96
3.4	Suprîncălzirea	97
3.5	Blocajul hârtiei la alimentarea manuală	97
3.7	Blocajul hârtiei la alimentarea automată ...	98
3.10	Alimentarea automată blocată de blocajul hârtiei	99
3.13	Deblocarea de urgență fără cheie.....	100
3.17	Curățarea dispozitivului.....	101

Dispozitivul dispune de o alimentare automată pentru stiva de coli care constă din coli individuale necutate (max. 100 g/m²). Ca regulă, nu este permisă prelucrarea hârtiei cu agrafe, atât cu agrafe de birou cât și cu capse. Condiția pentru aceasta o reprezintă dispunerea agrafelor la partea posterioară a tăvii de hârtie (în partea opusă utilizatorului). Pentru a prelungi durata de viață a dispozitivului, se recomandă totuși îndepărtarea agrafelor de birou/capselor înainte de operația de distrugere. În unele cazuri, în funcție de cantitatea și poziția agrafelor/capselor precum și de volumul stivei de hârtie cu agrafe/capse se poate ajunge la situații de alimentare greșită și prin aceasta la întreruperea operației de distrugere.

Uzura și deteriorările cauzate de utilizarea neadecvată și de intervențiile terților asupra aparatului nu fac obiectul garanției standard sau al garanției extinse

Distrugătorul de documente este conceput pentru utilizarea în zona privată și în birourile obișnuite.

Cu privire la numărul de coli specificat în datele tehnice se aplică următoarele condiții generale:

Numărul maxim de coli tăiate într-o singură fază poate fi asigurat în următoarele condiții: Rolă de tăiere noi sau lubrificate recent, motor rece, alimentare cu curent electric cu tensiunea nominală și frecvența nominală (230 V/50 Hz, 120 V/60 Hz). Eventualele abateri de la acești parametri pot duce la o performanță mai scăzută față de numărul de coli specificat și la un nivel de zgomot în funcționare mai ridicat.



Colile trebuie să fie introduse central și longitudinal, în unghi de 90°. De asemenea, performanța privind numărul de coli poate fi influențată și de proprietățile hârtiei și de modul în care se face alimentarea cu materiale.

1.2 Indicații privind siguranța

- Nu amplasați dispozitivul în apropierea unei surse de căldură!
- Depozitați, transportați și utilizați dispozitivul numai în poziție verticală!
- Utilizați pentru distrugătorul de documente numai lichide și gaze conforme cu reglementările DAHLE!
- Dispozitivul nu trebuie deschis!
- Utilizarea dispozitivului este permisă numai în spații închise, la temperaturi cuprinse între 10 °C și 25 °C (50 °F și 77 °F) și la o umiditate atmosferică fără condensare cuprinsă între 15 % și 95 %!
- Protecția la scurtcircuit a instalației electrice a clădirii trebuie să fie asigurată: max. 16 A (SUA max. 20 A).
- Nu lăsați distrugătorul de documente să funcționeze în gol!
- Aparatul nu este conceput pentru a fi utilizat de persoane (inclusiv copii) cu capacități fizice, senzoriale sau mentale limitate ori cu experiență și cunoștințe reduse, cu excepția situațiilor în care lucrează sub supraveghere sau sunt îndrumate în permanență în utilizarea aparatului de către o persoană care răspunde pentru siguranță.



Eliminați distrugătorul de documente în mod corect și ecologic, la un centru autorizat de colectare a deșeurilor. Nu aruncați componente ale distrugătorului de documente sau ale ambalajului la gunoiul menajer.



1.3 Legenda pictogramelor



Informație importantă



Consultați informațiile pentru utilizatori/
instrucțiunile privind siguranța



Atenție



A nu se utiliza în apropierea substanțelor
corozive.



Amplasați dispozitivul în poziție stabilă la
nivelul solului și la o distanță de 100 mm față
de perete, evitați acumularea de căldură,
Acționarea frânelor de blocare (în funcție de tip)



A nu se utiliza în apropierea lichidelor și a
gazelor inflamabile.



Pornire automată



A nu se expune la umezeală



Distrugătorul de documente nu este conceput
pentru a fi utilizat de copii (produsul nu este
un obiect de joacă).



Nu atingeți fanta pentru intrarea hârtiei cu
măinile.



Nu atingeți fanta pentru intrarea hârtiei cu
obiecte de îmbrăcăminte!



Nu atingeți fanta pentru intrarea hârtiei cu
părul!



Țineți la distanță tuburile de spray!



Îndepărtați capsele și clemele de hârtie înainte
de distrugerea documentelor!



Nu introduceți dischete!



Purtați ochelari de protecție când distrugeți
CD-uri/DVD-uri!



Înainte de executarea lucrărilor de întreținere,
deconectați dispozitivul de la alimentarea cu
curent!



Date tehnice - Rezervat dreptul de a efectua
modificări tehnice!



Nivelul de zgomot la funcționarea în gol



Viteză de tragere în interior



Tăierea în particule a hârtiei



Tăierea în particule a CD-urilor/DVD-urilor



Tăierea în particule a cardurilor



Greutate



Ștecherul servește ca dispozitiv de deconecta-
re de la alimentarea cu curent electric!



Priza trebuie să fie amplasată în vecinătatea
dispozitivului și să permită un acces ușor!



Utilizare



Distrugătorul de documente pregătit de func-
ționare



Distrugătorul de documente în funcțiune



Oprire automată!



În cazul unei funcționări mai îndelungate și/sau
în caz de suprasarcină, distrugătorul de docu-
mente se oprește automat în scop de răcire.



Instrucțiuni pentru lucrări de întreținere /
remediarea defecțiunilor



Recipient plin



Avarii posibile



Aparatul se oprește automat atunci când este
deschis



bg Указание за употреба



ВНИМАНИЕ!

ПРЕДИ пускане в експлоатация на машината за унищожаване на документи, прочетете ръководството за употреба и препоръките за безопасност.

Указанията трябва да се прилагат!

Съхранявайте ръководството за бъдеща употреба.



Съдържание

1	Важна информация	70
1.1	Използване по предназначение, гаранция	70
1.2	Указания за безопасност	71
1.3	Легенда на пиктограмите	72
1.4	Окомплектовка на доставката	88
1.5	Технически данни	88
2	Обслужване	89
2.2	Свързване на уреда към електрическата мрежа	89
2.3	Включване на уреда	89
2.4	Унищожаване на хартия	90
2.10	Непрекъснат ход	92
2.11	Блокиране	93
2.14	Унищожаване на CD/DVD, карти	94
3	Поддръжка/отстраняване на неизправности	96
3.1	Изпразване на изрезките	96
3.3	Отворен съд/капак	96
3.4	Прегряване	97
3.5	Задръстване на хартия ръчно подаване	97
3.7	Задръстване на хартия автоматично подаване	98
3.10	Задръстване на хартия блокирано автоматично подаване	99
3.13	Аварийно деблокиране без ключ	100
3.17	Почистване на уреда	101

1.1 Използване по предназначение, гаранция

Машината за унищожаване на документи е предназначена за унищожаване на хартия.

В зависимост от варианта на модела, освен това могат да се унищожават минимални количества от следните материали:

- CD/DVD, платежни и кредитни карти (виж Технически данни).
- телчета и кламери в количеството, обичайно за приложението им в хартиени документи (изключение: уреди с ниво на сигурност P6 и P7).

Уредът разполага с автоматично подаване за купчинна хартия, която се състои от несгънати единични листове (макс. 100 g/m²). Защипана с кламери или телчета хартия по правило може да бъде обработвана. За тази цел кламерите/телчетата трябва да се разположат в задната страна на отделението за хартия (отдалечено от потребителя). За удължаване на срока на експлоатация обаче, се препоръчва кламерите/телчетата да бъдат отстранени преди унищожаването. В отделни случаи, в зависимост от количеството и позицията на кламерите/телчетата, както и от обема на купчинната хартия, може да се стигне до грешно подаване и поради това – до прекъсване на процеса на унищожаване.

Гаранцията не покрива износване, повреди причинени от некомпетентна употреба или трети лица.

Машината за унищожаване на документи е разработена за частна употреба и нормална офис среда.

По отношение на посочената в техническите данни производителност в листове важат следните рамкови условия:

Максимален брой листове, които се режат с едно преминаване при следните условия: Нови, респ. смазани режещи ваялци, студен двигател, електрозахранване с номинално напрежение и номинална честота (230 V/50 Hz, 120 V/60 Hz). Отклонения могат да доведат до



1.2 Указания за безопасност

по-ниска производителност в листовے и до по-шумно рязане.

Листовете се подават в средата и надлъжно под 90°. В зависимост от характеристиките на хартията и подаването е възможно производителността в листовے също да варира.

- Указания за безопасност
- Уредът да не се поставя в близост до източник на топлина!
- Уредът да се складира, транспортира и експлоатира само в изправено положение!
- В уреда да се използват само течности и газове, които съответстват на директивите на DAHLE!
- Не се допуска отварянето на уреда!
- Уредът да се експлоатира само в затворени помещения, при 10°C до 25°C (50°F до 77°F) и некондензираща въздушна влажност от 15% до 95%!
- Трябва да се гарантира безопасността на инсталацията на сградата при късо съединение: макс. 16A (САЩ макс. 20A).
- Уредът да не се експлоатира на празен ход!
- Уредът не е предназначен за използване от лица (включително деца) с ограничени психични, сетивни или умствени способности или недостатъчен опит и знания, освен ако работят под надзор или са получили подробен инструктаж за използването на уреда от лице, което отговаря за безопасността.



Изхвърляйте машината за унищожаване на документи компетентно и екологично в оторизиран събирателен пункт. Не изхвърляйте части от машината за унищожаване на документи или от опаковката с битовата смет.



1.3 Легенда на пиктограмите



Важни информации



Да се прочете информацията за потребителя/препоръките за безопасност



ВНИМАНИЕ



Да не се използва в близост до разяждащи вещества.



Уредът да се постави стабилно на пода и на разстояние от 100 mm от стената, да се избягва акумулиране на топлина, Задействане на застопоряващите спирачки (в зависимост от типа)



Да не се използва в близост до горими течности или газове.



Автоматично пускане



Да не се излага на влага



Тази машина за унищожаване на документи не е предназначена за използване от деца (продуктът не е играчка).



Не докосвайте с ръце подаването на хартията.



Не докосвайте с части от облеклото подаването на хартията!



Не докосвайте с косите подаването на хартията!



Дръжте далеч флакони със спрей!



Кламерите да се отстраняват преди процеса на унищожаване!



Не вкарвайте дискети!



При унищожаване на CD/DVD носете защитни очила!



Преди работи по поддръжката, машината за унищожаване на документи да се изключи от електрозахранването!



Технически данни - запазено правото за технически промени!



Работен шум на празен ход



Скорост на поемане



Рязане на хартията на частици



Рязане на CD/DVD на частици



Рязане на карти на частици



Тегло



Мрежовият щепсел служи за разделящо устройство на електрозахранването.



Контактът трябва да е разположен в близост до уреда и да е лесно достъпен!



Употреба



Машина за унищожаване на документи в готовност



Машина за унищожаване на документи при работа



Автоматично изключване!



При по-дълга експлоатация и/или претоварване, машината за унищожаване на документи се изключва автоматично за охлаждане.



Указания за поддръжка / отстраняване на неизправности



Контейнер пълнен



Възможни неизправности



автоматично изключване при отворен корпус

tr Kullanım kılavuzu



DİKKAT!

Dosya yok edicisini çalıştırmadan ÖNCE kullanım kılavuzunu ve güvenlik uyarılarını dikkatle okuyun.



Uyarılar uygulanmalıdır!

Kullanım kılavuzunu bir başvuru kaynağı olarak dikkatle muhafaza edin.

İçindekiler

1	Önemli Bilgiler.....	73
1.1	Amacına Uygun Kullanım, Garanti	73
1.2	Güvenlik Uyarıları.....	74
1.3	Piktogram Açıklaması.....	75
1.4	Teslimat Kapsamı.....	88
1.5	Teknik Veriler	88
2	Kullanım.....	89
2.2	Cihazı Güç Kaynağına Bağlama	89
2.3	Cihazı Çalıştırma.....	89
2.4	Kağıt İmhası	90
2.10	Sürekli Besleme	92
2.11	Kilitleme	93
2.14	CD/DVD, Kart İmhası.....	94
3	Bakım / Arıza Giderme.....	96
3.1	Kesilen Atıkları Boşaltma.....	96
3.3	Hazne/Kapak Açık	96
3.4	Aşırı Isınma	97
3.5	Kağıt Yığınının Manuel Olarak İçeri Çekme ..	97
3.7	Kağıt Yığınının Otomatik İçeri Çekme.....	98
3.10	Kağıt Yığınının Kilitli Şekilde Otomatik İçeri Çekme.....	99
3.13	Anahtarsız Acil Kilit Açma.....	100
3.17	Cihazı Temizleme.....	101

1.1 Amacına uygun kullanım, garanti

Dosya yok edicisi kağıtların imha edilmesi için tasarlanmıştır.

Model türüne göre ayrıca aşağıdaki maddelerden az miktarda imha edilebilir:

- CD'ler/DVD'ler, çek ve kredi kartları (Teknik Verilere bakın).
- kağıt dokümanlarda, normal kapsamda mevcut ataçlar (İstisna: P6 ve P7 emniyet kademesi cihazlar).

Cihazda katlanmadan kalmış yapraklardan (100 g/ m²) oluşan kağıt kümeleri için otomatik bir içeri çekme özelliği bulunur. Genel olarak ataç ve raptiyelerle tutturulmuş kağıtlar işleminden geçirilebilir. Bunu yaparken önemli olan kağıt tepsisinin arka tarafındaki ataç veya raptiyelerin konumudur (kullanıcıya değil aşağıya bakmalıdır). Yine de cihazın kullanım ömrünü uzatmak için imha işleminden önce ataç veya raptiyeleri çıkarmanız önerilir. Bazı durumlarda ataç veya raptiyelerin miktarından ve konumundan ya da tutturulmuş sayfa kümelerinin yapısından bağımsız olarak hatalı şekilde içeri çekme gerçekleşebilir ve imha işlemi yarıda kesilebilir.

Aşınma, amacının dışında kullanım sonucu oluşan hasarlar ve üçüncü şahısların müdahaleleri garanti kapsamına girmez.

Dosya yok edicisi kişisel kullanım ve normal büro ortamı için tasarlanmıştır.

Teknik veriler doğrultusunda belirtilen sayfa performansı ile ilgili olarak aşağıdaki genel koşullar geçerlidir:

Bir geçişte aşağıdaki koşullar altında kesilen maksimum sayfa sayısı: Yeni, gerekirse yağlanmış kesme merdaneleri, soğuk motor, nominal gerilimi ve nominal frekansı ile elektrik beslemesi (230V/50Hz; 120V/60Hz). Sapmalar daha düşük bir sayfa performansına ve daha yüksek çalışma gürültüsüne yol açabilir.



1.2 Güvenlik uyarıları

Sayfalar ortalanarak ve uzunlamasına 90°lik açıyla yerleştirilir. Kağıt özelliklerine ve beslemeye göre sayfa performansı değişebilir.

- Cihazı, ısı kaynağının yakınına monte etmeyin!
- Cihazı sadece dik şekilde depolayın, taşıyın ve çalıştırın!
- Cihazda yalnızca DAHLE yönergelerine uygun sıvılar ve gazlar kullanın!
- Cihaz açılmamalıdır!
- Cihazı sadece kapalı mekanlarda, 10 C ile 25 C (50°F - 77°F) arasındaki sıcaklıklarda %15 ile %95 arasındaki yoğunlaşmayan hava nemliliğinde çalıştırın!
- Bina tesisatının kısa devre yapmaması sağlanmalıdır: maks. 16A (US maks. 20A).
- Cihazı boşta çalıştırmayın!
- Cihaz fiziksel, sensörel veya ruhsal yetenekleri sınırlı veya yeterli deneyime ve bilgiye sahip olmayan kişiler (çocuklar dahil) tarafından kullanılmamalıdır. Buna sadece gözetim altında oldukları zaman veya güvenliğinden sorumlu bir kişi tarafından cihazın kullanımı ayrıntılı olarak anlatılırsa izin verilir.



Dosya yok edicisini teknolojiye ve çevreye uygun bir şekilde yetkili bir toplama yerinde imha edin. Dosya yok edicisinin parçalarını veya ambalajını ev çöpüne atmayın.

1.3 Piktogram açıklaması



Önemli bilgi



Kullanıcı bilgisi/güvenlik uyarılarını okuyun



DİKKAT



Aşındırıcı maddelerin yakınında kullanmayın.



Cihazı güvenli duracak şekilde ve duvara 100 mm mesafede kurun, ısı birikmesini önleyin, Sabitleme frenlerini devreye alın (tipe bağlı)



Yanıcı sıvıların ve gazların yakınında kullanmayın.



Otomatik çalışma



Islaklığa maruz bırakmayın



Bu dosya yok edicisi çocuklar tarafından kullanılmak üzere tasarlanmamıştır (ürün, oyuncak değildir).



Kağıt beslemesine ellerinizle dokunmayın.



Kağıt beslemesine elbiseleriniz değmemelidir!



Kağıt beslemesine saçlarınızla dokunmayın!



Sprey kutularını uzak tutun!



Yok etmeden önce kısıkaçları ve ataçları çıkarın!



Disket yerleştirmeyin!



CD/DVD'yi imha ederken koruyucu gözlük takılmalıdır!



Bakım çalışmalarından önce dosya yok edicisini elektrik beslemesinden ayırın!



Teknik veriler - Teknik değişiklik yapma hakkı saklıdır!



Boşta çalışırken çalışma sesi



Çekme hızı



Kağıt partikül kesim



CD/DVD partikül kesim



Kart partikül kesim



Ağırlık



Fiş, elektrik kaynağından ayırma tertibatı olarak kullanılır.



Cihaz, prize yakın yere konmalı ve priz, kolayca ulaşılabilir olmalıdır!



Kullanım



Dosya yok edicisi hazır



Dosya yok edicisi çalışıyor



Otomatik kapatma!



Uzun süreli işletimde ve/veya aşırı yüklenme durumunda dosya yok edicisi otomatik olarak soğumak için kapanır.



Bakım bilgileri/arıza giderme



Hazne dolu



Olası arızalar



Gövde açık iken otomatik kapanma



el Οδηγίες χρήσης



ΠΡΟΣΟΧΗ!

ΠΡΙΝ από την έναρξη λειτουργίας του καταστροφέα εγγράφων διαβάσετε προσεκτικά το εγχειρίδιο χρήσης και τις υποδείξεις ασφαλείας.

Πρέπει να τηρούνται οι υποδείξεις!

Το εγχειρίδιο χρήσης πρέπει να φυλάσσεται για μεταγενέστερη χρήση.



Πίνακας περιεχομένων

1	Σημαντικές πληροφορίες	76
1.1	Ενδεδειγμένη χρήση, παροχές εγγύησης. ...	76
1.2	Υποδείξεις ασφαλείας	77
1.3	Λεζάντες εικονογραμμάτων	78
1.4	Παραδοτέα	88
1.5	Τεχνικά στοιχεία	88
2	Χειρισμός	89
2.2	Σύνδεση της συσκευής στο δίκτυο ρεύματος	89
2.3	Ενεργοποίηση συσκευής	89
2.4	Καταστροφή χαρτιού	90
2.10	Συνεχόμενη προώθηση	92
2.11	Κλειδωμά	93
2.14	Καταστροφή CD/DVD, καρτών	94
3	Συντήρηση/Αντιμέτωπιση βλαβών	96
3.1	Άδειασμα προϊόντων κοπής	96
3.3	Δοχείο/καπάκι ανοιχτό	96
3.4	Υπερθέρμανση	97
3.5	Συσώρευση χαρτιού χειροκίνητης εισαγωγής	97
3.7	Συσώρευση χαρτιού αυτόματης εισαγωγής	98
3.10	Συσώρευση χαρτιού κλειδωμένης αυτόματης εισαγωγής	99
3.13	Ξεκλείδωμα ανάγκης χωρίς κλειδί	100
3.17	Καθαρισμός συσκευής	101

1.1 Ενδεδειγμένη χρήση, παροχές εγγύησης

Ο καταστροφέας εγγράφων προορίζεται για την καταστροφή χαρτιών.

Ανάλογα με την έκδοση του μοντέλου, καταστρέφει επίσης και τα παρακάτω υλικά σε μικρές ποσότητες:

- CD/DVD, χρωστικές και πιστωτικές κάρτες (βλέπε Τεχνικά Στοιχεία).
- συνδετήρες και σύρματα συρραπτικών στις συνηθισμένες ποσότητες που χρησιμοποιούνται σε έγγραφα (εξαιρέση: συσκευές της κατηγορίας ασφαλείας Ρ6 και Ρ7).

Η συσκευή διαθέτει αυτόματη εισαγωγή για στοίβες φύλλων που αποτελούνται από μη διπλωμένα μεμονωμένα φύλλα (μέγ. 100 g/m²). Κατά κανόνα είναι δυνατή η επεξεργασία χαρτιών με συνδετήρες και συρραπτικά. Προϋπόθεση είναι οι συνδετήρες να βρίσκονται στην πίσω πλευρά της θήκης χαρτιού (αντίθετα από τον χρήστη). Ωστόσο, για τη μεγάλη διάρκεια ζωής της συσκευής συνιστάται να αφαιρούνται οι συνδετήρες και τα συρραπτικά πριν από την καταστροφή. Σε μεμονωμένες περιπτώσεις, ανάλογα με την ποσότητα και τη θέση των συνδετήρων καθώς και τον όγκο της στοίβας χαρτιών με συνδετήρες μπορεί να προκύψει εσφαλμένη εισαγωγή και συνεπώς διακοπή της διαδικασίας καταστροφής.

Η φθορά, οι ζημιές από ακατάλληλη χρήση καθώς και οι επεμβάσεις από τρίτους δεν περιλαμβάνονται στις παροχές της εγγύησης ούτε καλύπτονται από την εγγύηση.

Ο καταστροφέας εγγράφων έχει σχεδιαστεί για ιδιωτική χρήση και κανονικές συνθήκες γραφείου.

Σχετικά με την απόδοση σε φύλλα που αναφέρεται στα παρακάτω τεχνικά στοιχεία ισχύουν οι ακόλουθες προϋποθέσεις πλαισίου:

Μέγιστο πλήθος φύλλων, που κόβεται σε μία διέλευση υπό τις ακόλουθες προϋποθέσεις: Καινούργιοι ενδεχ. λιπασμένοι κύλινδροι κοπής, ψυχρός



1.2 Υποδείξεις ασφαλείας

κινητήρας, τροφοδοσία ρεύματος με ονομαστική τάση και ονομαστική συχνότητα (230 V/50 Hz, 120 V/60 Hz). Τυχόν αποκλίσεις μπορεί να οδηγήσουν σε μειωμένη απόδοση σε φύλλα και σε αυξημένους θορύβους λειτουργίας.







Τα φύλλα τροφοδοτούνται κεντρικά και κατά μήκος κάτω από 90°. Ανάλογα με τις ιδιότητες του χαρτιού και την τροφοδοσία, η απόδοση σε φύλλα μπορεί και να διαφέρει.

- Υποδείξεις ασφαλείας
- Η συσκευή δεν επιτρέπεται να τοποθετείται κοντά σε πηγές θερμότητας!
- Αποθηκεύετε, μεταφέρετε και λειτουργείτε τη συσκευή μόνο σε όρθια θέση!
- Χρησιμοποιείτε στη συσκευή μόνο υγρά και αέρια που πληρούν τις οδηγίες DAHLE!
- Η συσκευή δεν επιτρέπεται να ανοίγεται!
- Η λειτουργία της συσκευής επιτρέπεται μόνο σε κλειστούς χώρους, με θερμοκρασία από 10°C έως 25°C (50°F έως 77°F) και μη συμπυκνούμενη υγρασία αέρα από 15% έως 95%!
- Πρέπει να διασφαλίζεται η ασφάλεια βραχυκυκλώματος της κτιριακής εγκατάστασης: έως 16A (Η.Π.Α. έως 20A).
- Η συσκευή δεν πρέπει να λειτουργεί άδεια!
- Η συσκευή δεν προορίζεται για χρήση από άτομα (συμπεριλαμβανομένων παιδιών) με περιορισμένες φυσικές, αισθητηριακές ή πνευματικές ικανότητες ή ελλιπή εμπειρία και γνώσεις, εκτός αν εργάζονται υπό επίτηρηση ή έχουν λάβει λεπτομερείς οδηγίες σχετικά με τη χρήση της συσκευής από άτομο υπεύθυνο για την ασφάλεια.



Ο καταστροφές εγγράφων πρέπει να απορρίπτεται σωστά και με περιβαλλοντικά ορθό τρόπο σε εξουσιοδοτημένο κέντρο συλλογής. Μην ρίχνετε μέρη του καταστροφέα εγγράφων ή της συσκευασίας στα οικιακά απορρίμματα.

1.3 Λεζάντες εικονογραμμάτων

-  Σημαντική πληροφορία
-  Διαβάστε τις πληροφορίες χρήστη και τις υποδείξεις ασφαλείας
-  ΠΡΟΣΟΧΗ
-  Δεν επιτρέπεται η χρήση κοντά σε διαβρωτικά υλικά.
-  Η συσκευή πρέπει να τοποθετείται με στατική ασφάλεια στο δάπεδο, σε απόσταση 100 mm από τον τοίχο και να αποφεύγεται η συσσώρευση θερμότητας. Να χρησιμοποιούνται τα φρένα ακινητοποίησης (ανάλογα με τον τύπο)
-  Δεν επιτρέπεται η χρήση κοντά σε εύφλεκτα υγρά ή αέρια.
-  Αυτόματη εκκίνηση λειτουργίας
-  Δεν επιτρέπεται η έκθεση σε υγρασία
-  Αυτός ο καταστροφέας εγγράφων δεν προορίζεται για χρήση από παιδιά (το προϊόν δεν είναι παιχνίδι).
-  Μην αγγίζετε με τα χέρια την τροφοδοσία χαρτιού.
-  Μην αγγίζετε με μέρη της ενδυμασίας την τροφοδοσία χαρτιού!
-  Τα μαλλιά σας δεν πρέπει να αγγίζουν την τροφοδοσία χαρτιού!
-  Κρατάτε μακριά τυχόν δοχεία ψεκασμού!
-  Οι συνδετήρες γραφείου και συρραπτικών πρέπει να αφαιρούνται πριν από τη διαδικασία καταστροφής!
-  Μην εισάγετε δισκέτες!
-  Κατά την καταστροφή CD/DVD να φοράτε προστατευτικά γυαλιά!
-  Πριν από εργασίες συντήρησης αποσυνδέετε τον καταστροφέα εγγράφων από την τροφοδοσία ρεύματος!

-  Τεχνικά στοιχεία - Με την επιφύλαξη του δικαιώματος τεχνικών αλλαγών!
-  Ένταση ήχου σε άδεια λειτουργία
-  Ταχύτητα εισαγωγής
-  Κοπή χαρτιού σε τεμάχια
-  Κοπή CD/DVD σε τεμάχια
-  Κοπή καρτών σε τεμάχια
-  Βάρος
-  Το φως δικτύου ρεύματος χρησιμεύει ως διάταξη αποσύνδεσης της τροφοδοσίας ρεύματος.
-  Η πρίζα πρέπει να είναι τοποθετημένη κοντά στη συσκευή και να είναι εύκολα προσβάσιμη!
-  Χειρισμός
-  Καταστροφέας εγγράφων σε λειτουργική ετοιμότητα
-  Καταστροφέας εγγράφων σε λειτουργία
-  Αυτόματη απενεργοποίηση!
-  Κατά την παρατεταμένη λειτουργία και/ή υπερφόρτωση ο καταστροφέας εγγράφων μεταβαίνει αυτόματα σε λειτουργία ψύξης.
-  Υποδείξεις συντήρησης / Αντιμετώπιση βλαβών
-  Κάδος γεμάτος
-  Πιθανές διαταραχές
-  Αυτόματη απενεργοποίηση με ανοιχτό περίβλημα

**انتبه!**

قم بقراءة دليل الاستعمال وتعليمات الأمان بعناية قبل بدء تشغيل ماكينة تقطيع الورق. لا بد من تطبيق هذه التعليمات. احتفظ بدليل الاستعمال لاستخدامه لاحقاً.

المحتويات

79	1	معلومات هامة.
79	1.1	الاستخدام المطابق للتعليمات، الضمان
80	1.2	تعليمات السلامة
80	1.3	رموز الرسم التوضيحي
88	1.4	المحتويات المؤرّدة
88	1.5	المواصفات التقنية
89	2	الاستخدام
89	2.2	توصيل الجهاز بمأخذ التيار الكهربائي
89	2.3	تشغيل الجهاز
90	2.4	إتلاف الورق
92	2.10	التشغيل المستمر
92	2.11	القفل
	2.14	إتلاف الأقراص المضغوطة / أقراص الفيديو الرقمية، والبطاقات
94	3	الصيانة / إزالة الأعطال
96	3.1	تفريغ القصاصات
97	3.3	الحاوية / الغطاء مفتوح
97	3.4	ارتفاع في درجة الحرارة
97	3.5	تكسد الورق في وحدة التغذية اليدوية
98	3.7	تكسد الورق في وحدة التغذية الأوتوماتيكية
	3.10	تكسد الورق في وحدة التغذية الأوتوماتيكية
99		المؤمنة
100	3.13	تحرير القفل عند الطوارئ دون مفتاح
101	3.17	تنظيف الجهاز

يحتوي الجهاز على وحدة تغذية أوتوماتيكية لرزم الأوراق التي تتكون من أوراق فردية غير مثنية (١٠٠ جم / م² كحد أقصى). يمكن في المعتاد معالجة الأوراق المدبسة، سواء باستخدام مشابك الورق أو باستخدام الدبابيس. والشرط الأساسي لهذا هو تنسيق المشابك والدبابيس على الجانب الخلفي من درج الورق (المتجه بعيداً عن المستخدم). ومع ذلك، يوصى لإطالة عمر الجهاز بإزالة أي مشابك ورقية / دبابيس قبل إتلاف الورق. وفي بعض الحالات، اعتماداً على كمية الدبابيس وموضعها، وحجم رزم الأوراق المدبسة، يمكن أن يؤدي ذلك إلى خلل في التغذية، وبالتالي إلى توقف عملية الإتلاف.

لا يدخل البلى والتلفيات الناجمة عن الاستخدام غير الصحيح أو إجراء إصلاحات أو تعديلات بمعرفة جهات أخرى ضمن نطاق الضمان أو التأمين.

ماكينة تقطيع الورق هذه مخصصة للاستخدام في نطاق الاستخدامات الشخصية ونطاقات المكاتب العادية. فيما يتعلق بسعة الورق المنصوص عليها في البيانات التقنية تطبق الشروط العامة التالية:

الحد الأقصى لعدد الأوراق المقطوعة دفعة واحدة تحت الشروط التالية: أسطوانات قطع جديدة، ومزيتة إذا لزم الأمر، محرك بارد، وتغذية كهربائية بجهد اسمي وتردد اسمي (٢٣٠ فولت / ٥٠ هرتز، ١٢٠ فولت / ٦٠ هرتز). الانحرافات يمكن أن تؤدي إلى انخفاض معدل سعة الورق وزيادة الضوضاء أثناء التشغيل.

يتم تغذية الأوراق في المنتصف وبالطول في اتجاه ٩٠ درجة. قد تختلف سعة الورق أيضاً اعتماداً على خصائص الورق والتغذية.



1.2 تعليمات السلامة

- لا تضع الماكينة بالقرب من مصدر حرارة!
- لا تُخزّن الماكينة ولا تُنقل ولا تُشغل إلا وهي قائمة في وضع رأسي!
- لا تُستخدم في الماكينة إلا السوائل والغازات التي تتفق مع توجيهات شركة DAHLE!
- لا تقم بفتح الماكينة!
- لا يجب تشغيل الجهاز في الأماكن المغلقة إلا ضمن درجات حرارة تتراوح ما بين ١٠ وحتى ٢٥ درجة مئوية (٥٠ إلى ٧٧ درجة فهرنهايت) وفي رطوبة غير مكثفة تتراوح ما بين ١٥% إلى ٩٥%!
- يجب الحماية من قصر الدائرة بتركيبات البناء: الحد الأقصى ١٦ أمبير (٢٠ أمبير بحد أقصى في الولايات المتحدة).
- لا يتم تشغيل الماكينة على سرعة التباطؤ!
- الجهاز غير مخصص للاستخدام بواسطة أشخاص (بما في ذلك الأطفال) ممن لديهم ضعف في القدرات الجسدية أو الحسية أو العقلية أو ممن لديهم نقص خبرة ومعرفة إلا تحت إشراف أو بتلقي تعليمات تفصيلية عن استخدام الجهاز من قِبَل شخص يكون مسئولاً عن السلامة.

تخلص من ماكينة تقطيع الورق بطريقة سليمة
وصديقة للبيئة بإحدى نقاط التجميع المعتمدة.
لا تضع أي جزء من أجزاء ماكينة تقطيع الورق أو تغليفها في القمامة المنزلية.



1.3 رموز الرسم التوضيحي

- معلومات هامه
- اقرأ معلومات المستخدم/تعليمات الأمان
- تنبيه / احترس
- لا تُستخدم بالقرب من مواد كاوية.
- توضع ماكينة تقطيع الورق في وضع مستقر على الأرضية وعلى مسافة ١٠٠ ملم من الحائطه تجنب الحرارة المتخلفة.
- يُضغَط على فرامل التثبيت (متعلق بالنوع)
- لا تُستخدم بالقرب من سوائل أو غازات سريعة الاشتعال.
- يتم التشغيل أوتوماتيكياً
- لا تُعرَّض للبلل
- ماكينة تقطيع الورق هذه غير مخصصة لاستخدام الأطفال (لا يعتبر المنتج لعبة).
- لا تلمس مغذي الورق بيديك.
- لا تلمس مغذي الورق بقطع من الملابس.
- لا تلمس مغذي الورق بيديك.
- أبعدها عن علب الرذاذ!
- يجب إزالة مشابك ودبابيس الورق قبل إجراء عملية تقطيع الورق!
- لا تقم بإدخال الأقراص!
- عند تدمير CD / DVD ، يجب ارتداء نظارات السلامة!



قبل القيام بأعمال الصيانة يجب فصل ماكينة تقطيع الورق عن إمداد الطاقة!



البيانات التقنية -



يُحتفظ بالحق في عمل تغييرات تقنية!

مستوى صوت التشغيل على سرعة التباطؤ



سرعة التغذية



تقطيع الورق على شكل جزئيات صغيرة



تقطيع الأقراص المضغوطة/أقراص DVD على شكل



جزئيات صغيرة

قطع البطاقات البلاستيكية في شكل جزئيات صغيرة



الوزن



يُستخدم قابس التيار كتجهيزة قطع لإمداد الطاقة.



يجب تركيب المقبس بالقرب من الجهاز وفي مكان



يمكن الوصول إليه بسهولة!

الاستعمال



ماكينة تقطيع الورق في وضع الاستعداد



ماكينة تقطيع الورق قيد التشغيل



الفصل الأوتوماتيكي!



عند التشغيل لفترات طويلة و/أو التحميل الزائد



تفصل ماكينة قطع الأوراق أوتوماتيكيًا للتبريد.

تعليمات الصيانة / إصلاح الأعطال



الوعاء ممتلئ



حالات الخلل المحتملة



الفصل الأوتوماتيكي عند التشغيل عند فتح العلبة





ja 取扱説明書

**注意!**

ご使用の前に、本製品の取扱説明書に記載されている使い方や安全上の注意をよくお読みください。



安全上の指示を必ず守ってご使用ください。

取扱説明書はいつでも読めるように保管しておいてください

目次

1	重要事項	82
1.1	正しい使用法	
	製品の保証について	82
1.2	安全上の注意	83
1.3	ピクトグラムの説明	83
1.4	製品の内容	88
1.5	技術仕様	88
2	操作	89
2.2	装置を電源に接続する	89
2.3	装置のスイッチを入れる	89
2.4	用紙の裁断	90
2.10	連続細断	92
2.11	ロック機能	93
2.14	CD/DVD、カードの裁断	94
3	メンテナンス / トラブルシューティング	96
3.1	ダストボックスを空にする	96
3.3	ダストボックス/カバーが開いている	96
3.4	装置の過熱	97
3.5	手動フィードの紙詰まり	97
3.7	オートフィードの紙詰まり	98
3.10	ロック中のオートフィードの紙詰まり	99
3.13	キーなしでの緊急ロック解除	100
3.17	お手入れ方法	101

1.1 正しい使用法、製品の保証について

このシュレッダーは紙を細断するためにつくられています。

機種によっては、次のものを少量ずつ細断できるタイプもございます：

- CD/DVD、キャッシュカード、クレジットカード（技術仕様をご確認ください）。
- 一般的な文書類に使用される、市販のホチキス（セキュリティレベルP6およびP7は除く）。

本機は折られていない用紙（100g/m²以下）の束をオートフィードで処理します。基本的には、クリップやホチキスで綴じた紙も裁断することが可能です。この場合は必ず用紙トレイの後方（使用者と離れた場所）にホチキス等が来るように置いてください。ただし、本機の寿命を延ばすためにも、予めクリップやホチキスを取り外してご使用いただくことをお勧めします。ホチキス等の数と場所、および用紙の枚数によっては、紙送りエラーが生じて裁断処理が停止することがあります。

指示に従わなかったり、用途以外のものを投入したことで生じた故障や損害について、当社は一切の責任を負いません。また、これらの故障や損害は当社保証の対象外となります。

本シュレッダーは、個人使用および一般的な事務での使用向けに設計されています。技術仕様に記載の処理能力に応じて、以下の条件が適用されます。

一回に挿入できる枚数は、以下の条件で定義したものです。新品もしくはオイルを塗布したローラー、エンジン冷間状態、公称電圧および公称周波数（230V/50Hz; 120V/60Hz）での電源供給。上記以外の条件で使用した場合は、挿入できる枚数が減ったり音が大きくなることがあります。

用紙は中央から縦方向に、90度以上曲げずに挿入。用紙の性質や入れ方によっては、処理内容に変化が生じる可能性があります。



1.2 安全に関するご注意

- 本機を熱源のそばに置かないでください。
- 本機は決して倒さず、縦にして保管や移動をしてください。
- ダーレ社の純正シュレッダーオイル、ガス以外は使用しないでください。
- 本体を決して開けないでください。
- 本機は温度 10 °C～25 °C (50 °F～77 °F) の閉めきった部屋で使用してください。また、湿度は 15 %～95 %以内を保ち、結露しないように注意してください。
- 建物の配線設備の短絡保護装置が正常に作動することをご確認ください (最大16 A、米国では20 A)。
- 本機を空回りさせないでください。
- 身体上の理由または知覚・精神上的理由から操作に困難を伴う方 (お子様も含む) や、装置の操作に関する経験と知識が不十分な方は、本機を単独でご使用にならないでください。上記の方が本機を扱う際は、安全面で責任を持てる方が付き添って操作し、操作について十分な指導を行うことが必須要件となります。



シュレッダーを廃棄する際は分別方法および環境に配慮し、自治体の指示に従ってください。シュレッダーのパーツや梱包材は、一般ごみとして廃棄しないでください

1.3 ピクトグラムの説明



重要事項



取扱説明書/安全に関する注意事項をお読みください



注意



本製品を錆びつく恐れのある物質の近くで使用しないでください。



本機は床にしっかり安定させ、壁面から100 mm 離して設置してください。また、本体内部が過熱しないよう注意し、必ずストッパーを使用してください (機種により異なる)



可燃性の液体やガスの近くでは使わないでください。



オートスタート



湿度の高い場所に放置しないでください。



本製品は、お子様向けのものではありません。(シュレッダーで遊ばないこと)。



用紙投入口に手を触れないでください。



用紙投入口に服が巻き込まれないようご注意ください。



用紙投入口に髪の毛が巻き込まれないようご注意ください。



スプレー缶を近づけないでください。



用紙クリップやホチキスはシュレッダーにかける前に外してください。



フロッピーディスクは本機で裁断できません。



CD/DVDを廃棄する際は、必ず保護メガネを着用すること!



メンテナンスを行う前に、必ず電源プラグを抜いてください。



技術仕様 - 内容は予告なく変更される場合があります



空回り時の騒音レベル



細断速度



用紙 - クロスカット



CD/DVD - クロスカット



カード - クロスカット



質量



プラグで電源の入/切を行います



電源プラグは必ず装置付近のコンセントに差し込み、いつでも抜くことができるようにしてください。



操作



スタンバイ中



作動中



オートオフ



長時間作動したり過負荷の状態になると、自動的にオフになって本体を冷まします。



メンテナンスについて / トラブルの解消



ダストボックスが満杯です



故障かなと思ったら



本機が開いたままになった場合のオートオフ機能



zh 使用说明

**注意!**

使用碎纸机之前，请仔细阅读本操作说明书和安全指南。



必须遵守本指南的内容!

妥善保管本操作说明书，以备将来使用。

目录

1	重要信息	85
1.1	常规使用，保修	85
1.2	安全指南	86
1.3	图形符号图例	86
1.4	供货范围	88
1.5	技术数据	88
2	操作	89
2.2	将设备与电源相连	89
2.3	接通设备	89
2.4	纸张粉碎	90
2.10	持续进纸	92
2.11	联锁装置	93
2.14	CD/DVD、卡片粉碎	94
3	保养/故障排除	96
3.1	清空粉碎物	96
3.3	容器/盖板呈打开状态	96
3.4	加热	97
3.5	手动送纸塞纸	97
3.7	自动送纸塞纸	98
3.10	联锁后自动送纸塞纸	99
3.13	不使用扳手紧急解锁	100
3.17	清洁设备	101

1.1 预定用途，保修

本碎纸机用于粉碎纸张。

根据机器型号的不同可以粉碎少量以下物品：

- CD/DVD、支票和信用卡（详见技术数据）。
- 在纸质文档中以及通常使用的订书钉及回形针（例外情况：P6 和 P7 安全等级设备）。

设备拥有一个纸张堆自动进纸装置，纸张堆由折叠的单页纸组成（最高100g/m²）。正常情况下可以一同处理装订后的纸，既包括使用曲别针，也包括使用订书钉装订的纸。这时前提是订书钉排列在纸盒后侧（避开用户）。但为了延长设备的使用寿命，推荐在粉碎前移除曲别针/订书钉。在个别情况下，根据订书钉数量和位置的不同以及装订后纸张堆规模的不同，可能出现错误进纸，由此导致粉碎过程中断。

由于不恰当使用或从第三方购买造成的磨损及损坏不属于保修或保证范围。

碎纸机设计用于在私人场所和正常办公环境下运行。

根据技术数据页数容量的规定，适用下列条件：

在下列条件下单次切碎的最大纸张数量：加润滑油过的新碎纸辊（若有必要）、冷电动机、具有额定电压和频率（230 伏特/50 赫兹；120 伏特/60 赫兹）。偏差可能导致较低的纸张容量，并在操作期间增加噪音。纸张应在 90°C 下纵向置中插入。纸张容量可能因为纸张特性与入口不同而变化。



1.2 安全指南

- 不要将本设备置于热源附近!
- 本设备只能以直立状态放置、运输及运行!
- 本设备上只能使用符合 DAHLE 规定的液体或气体!
- 不要打开本设备!
- 本设备只能在温度为 10° C 至 25° C (华氏 50° F 到 77° F) 且非凝湿度为 15% 至 95% 的室内使用!
- 确保房屋安装的短路保险丝工作正常: 最大电流 16 安 (美国最大电流 20 安)。
- 不要让设备空转!
- 身体、知觉或精神有障碍以及缺乏设备操作经验知识的人士 (包括孩子) 不得操作该设备。正常人只有在安全人员监督下, 或得到全面设备使用指导的情况下才可使用设备。



以专业环保方式报废碎纸机, 将垃圾送到认可的回收站处置。请不要将碎纸机的部件或包装与生活垃圾一同处置。

1.3 图形符号图例



重要信息



阅读使用者信息/安全指南



注意



使用时请远离腐蚀性物品。



将本设备平稳地直立在地面上, 离墙 100 毫米, 避免操作紧急制动时, 热量积聚 (取决于型号)



使用时请远离易燃易爆液体及气体。



自动开机



不要暴露在潮湿的环境中



不要让儿童使用本碎纸机 (本产品不是玩具)。



请不要用手接触进纸入口。



请不要让衣服接触进纸入口!



请不要让毛发接触进纸入口!



远离喷雾罐!



请在销毁文件前去掉回形针和钉书针!



未插入软盘!



销毁 CD / DVD 时, 必须佩戴护目镜!



维修碎纸机前要断电!



技术数据 — 保留技术变更的权利!



空转时的机器噪音



卷入速度



纸张碎粒



CD/DVD 碎粒



卡片碎粒



重量



电源插头用作断电装置!



插座应安装在设备附近，可以轻易接触到!



操作



准备状态下的碎纸机



使用状态下的碎纸机



自动关机!



在延长操作时间和/或过载时，碎纸机会自动关机以降温。



维护指南 / 故障排除



容器已满



可能的故障



打开机壳时会自动关机

1



1.4

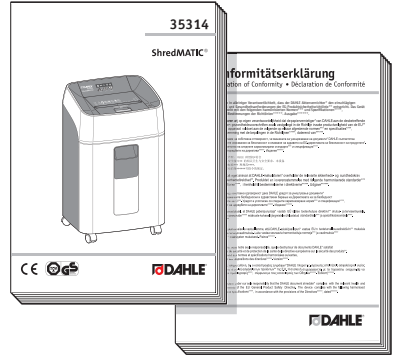
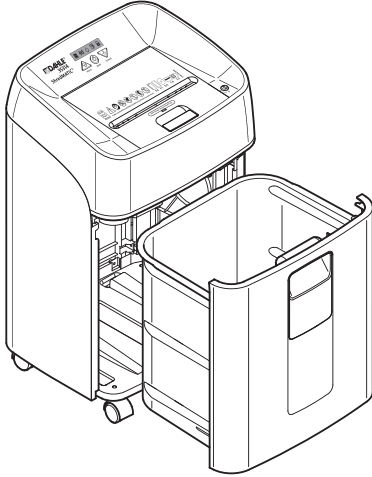

1.5

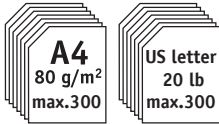

2,5m/min



2,5m/min

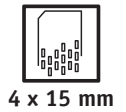
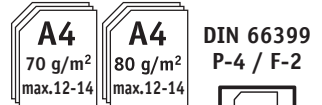

220 - 240 V / 50 - 60 Hz
110 - 120 V / 50 - 60 Hz

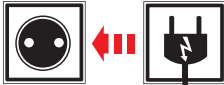

DIN 66399 T-4 / E-3



max 1

DIN 66399 0-3

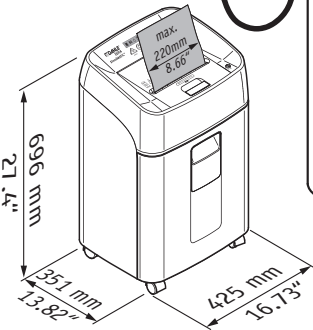

≤54 dB (A)



18 kg
40 lbs



40 l / 10.5 gal

2



2.1



2.2

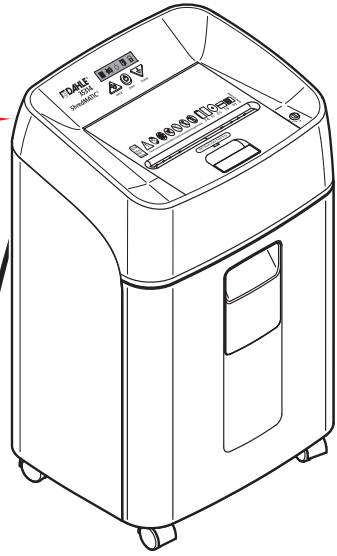
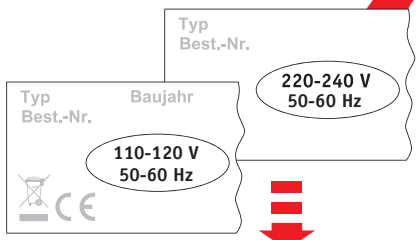

2.3

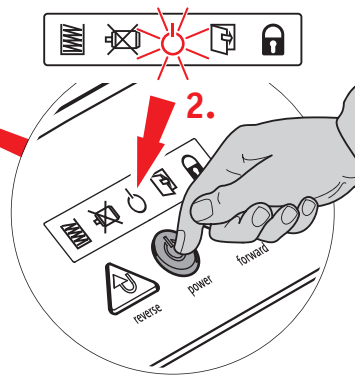
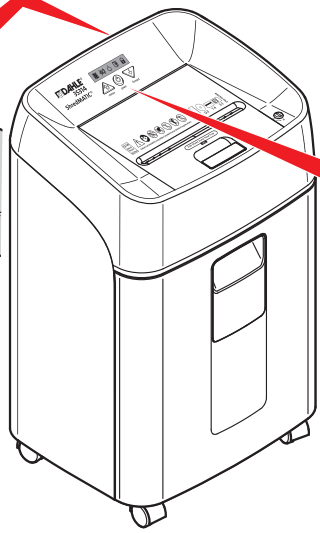
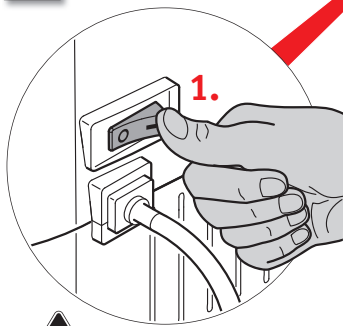

2



2.4



2.5

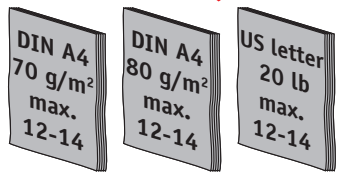
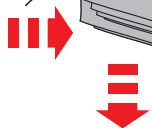
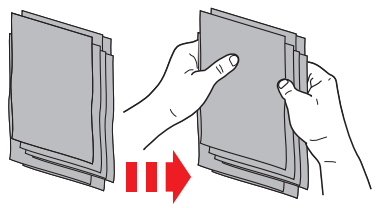

O.K.

O.K.

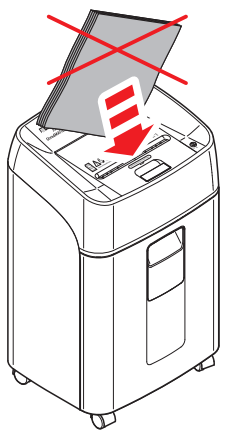

2.6

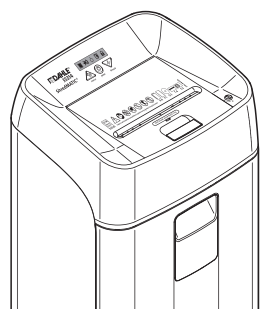
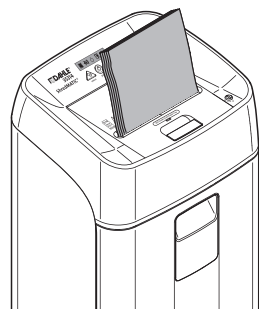
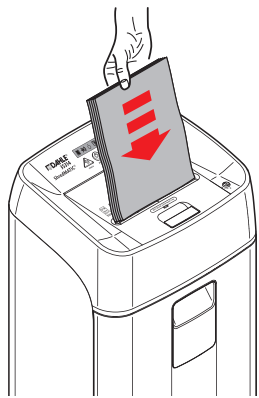



2.7

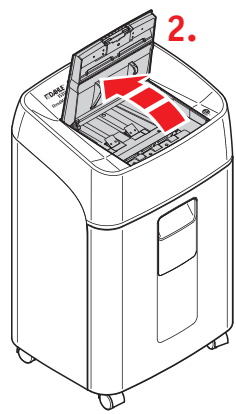
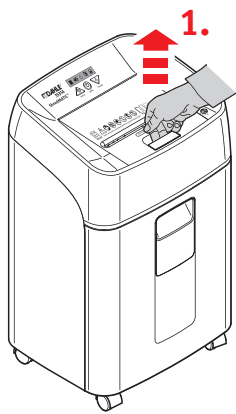

O.K.

2.8

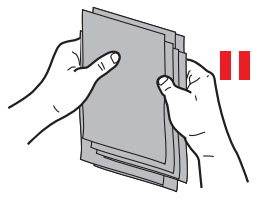

O.K.

DIN A4
80 g/m²
max.300

DIN A4
70 g/m²
max.300

US letter
20 lb
max. 300

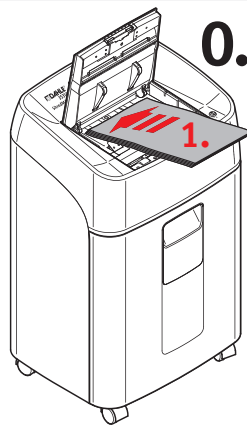

O.K.

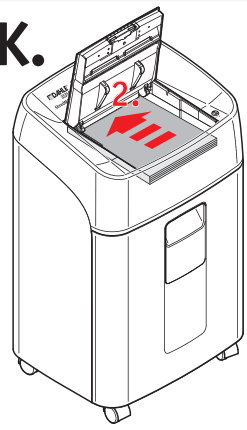

2.9

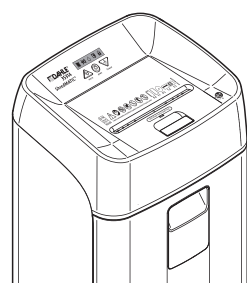
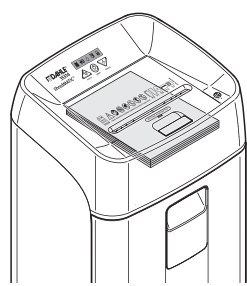
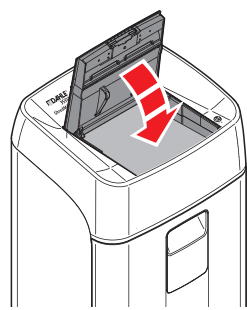



2.10

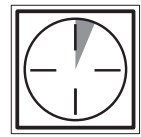
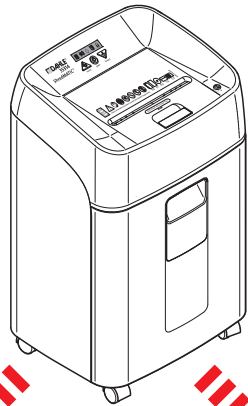
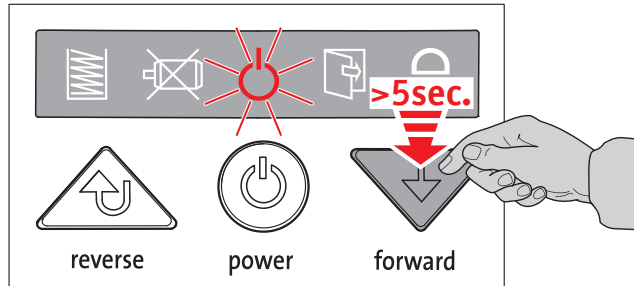

5min

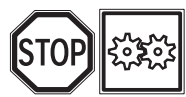
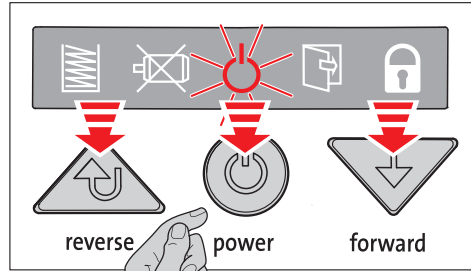
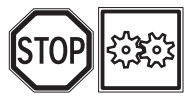



2.11

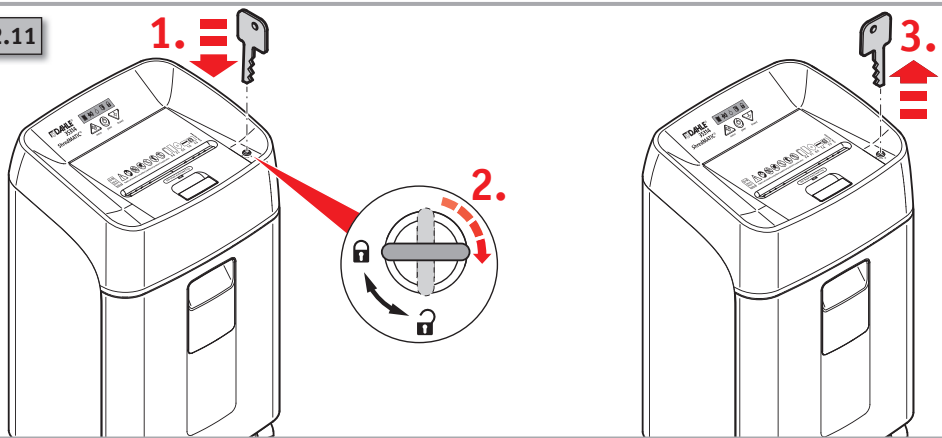

2.12

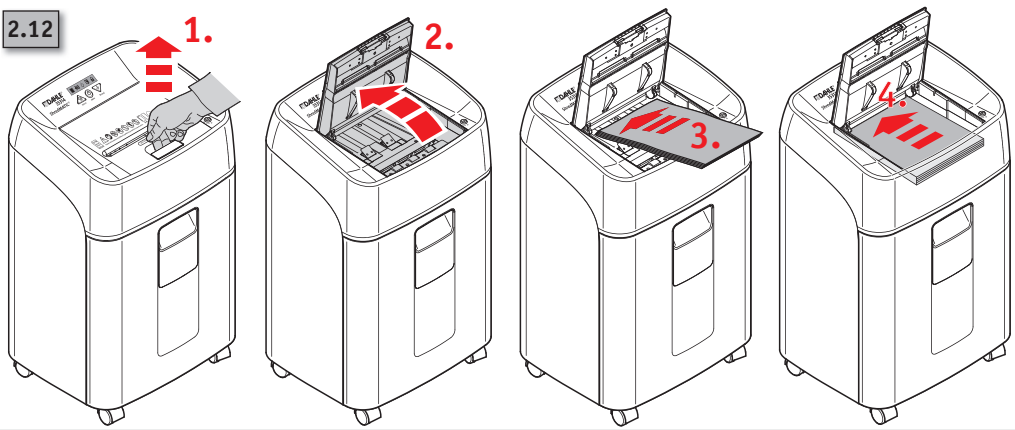

2.13

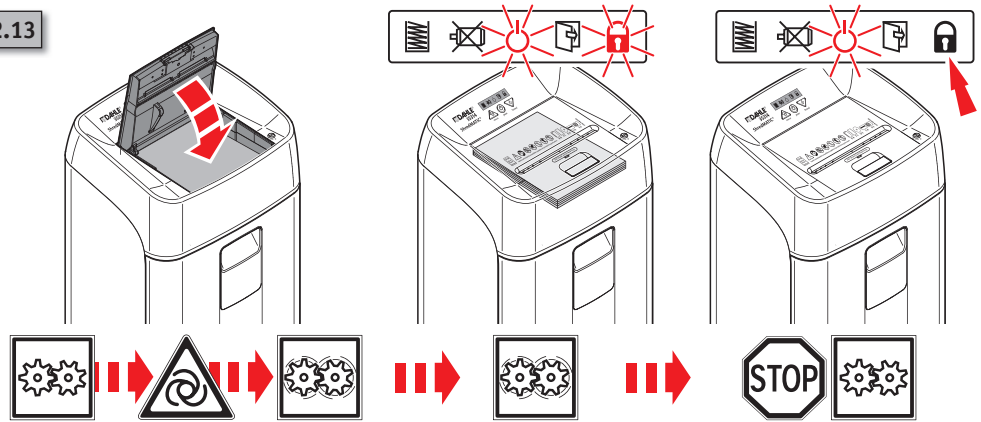

2



2.14



2.15

O.K.

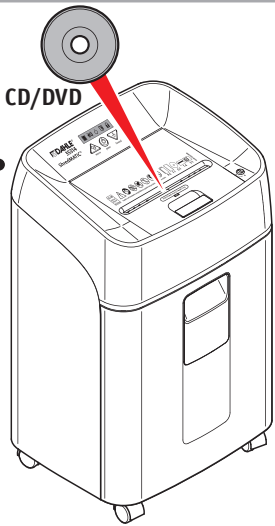

CD/DVD

O.K.

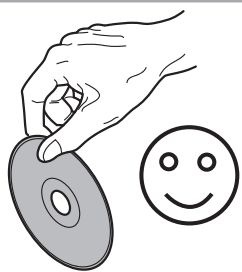

~~O.K.~~

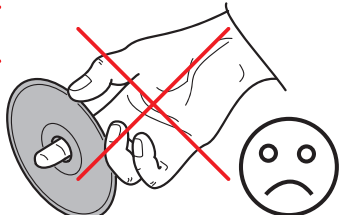

2.16

max. 1

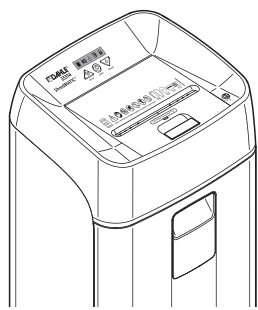
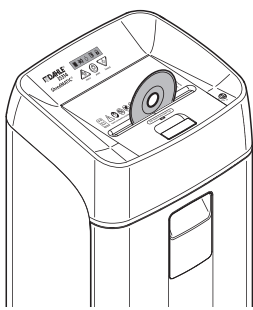
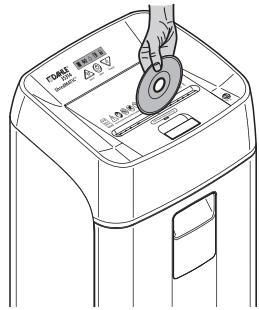



2.17

Credit card max. 1

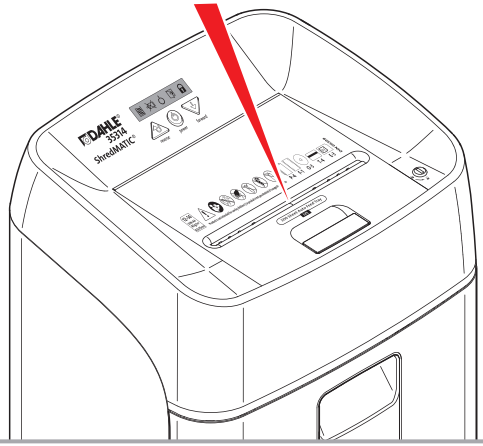

O.K.

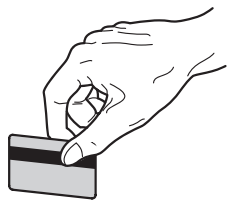

~~O.K.~~

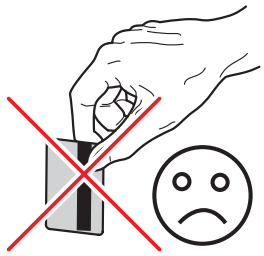

2.18

max. 1

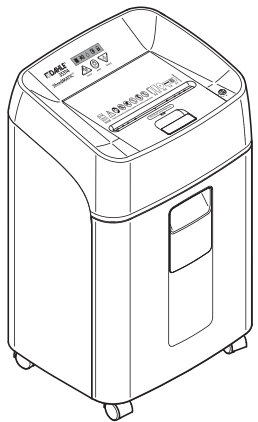
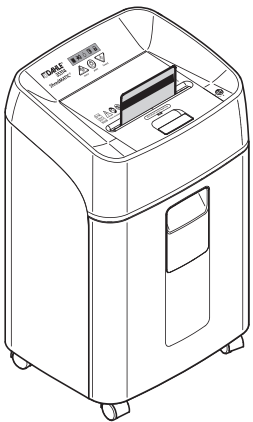
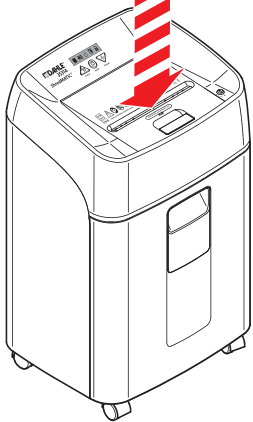

3



3.1



~~O.K.~~

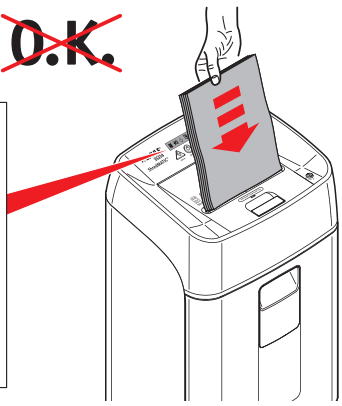
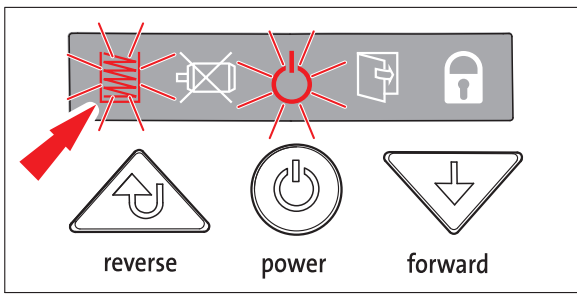

3.2



1.

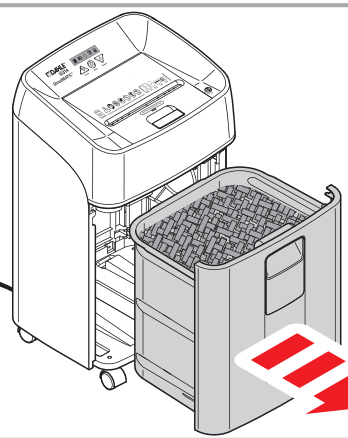

3.

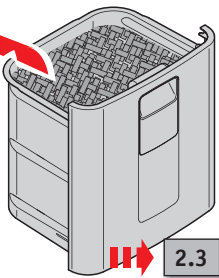

2.



2.3

3.3

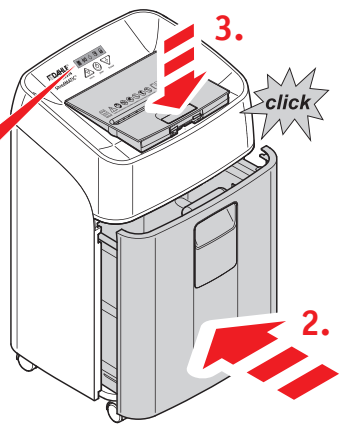
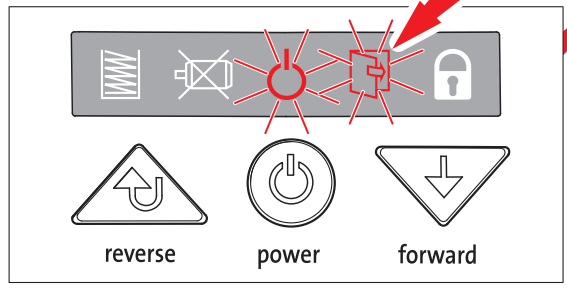

click

2.



3.4



2.5

reverse power forward

reverse power

3.5



reverse power forward

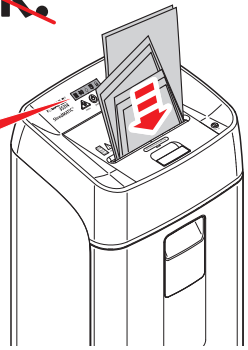

3.6

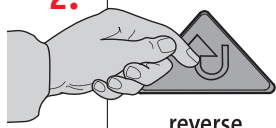

reverse power

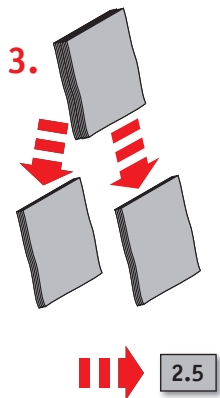

3



3.7



~~O.K.~~

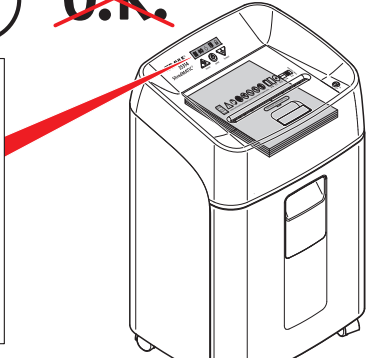
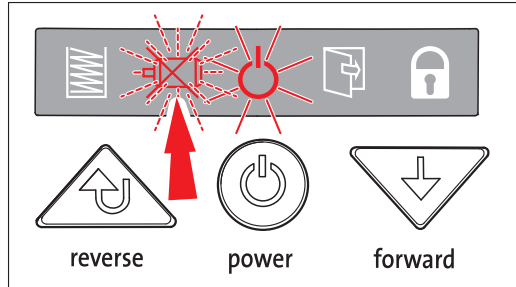

3.8

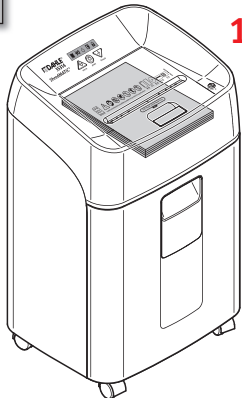

1. 3 Sek.

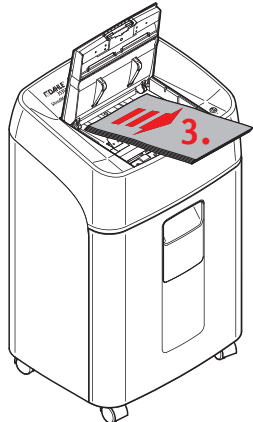
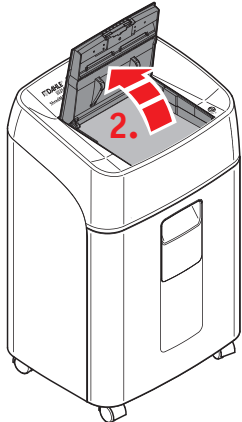

3.9

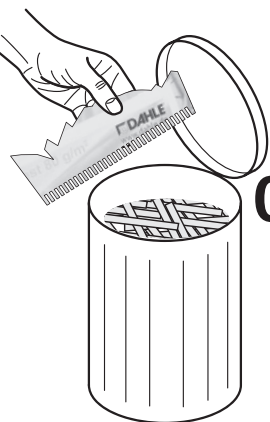
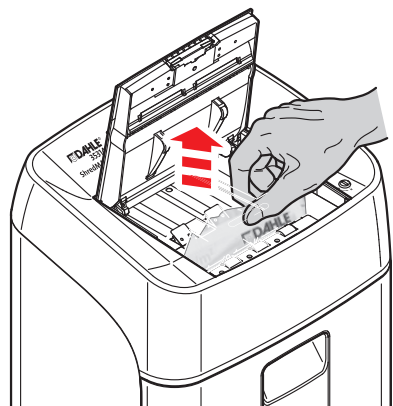

O.K.



3.10

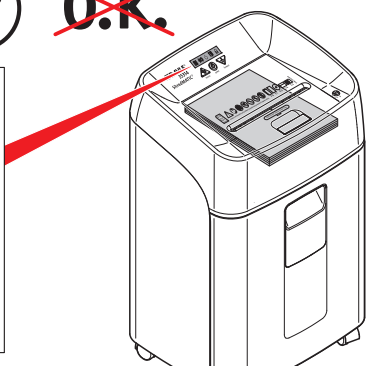
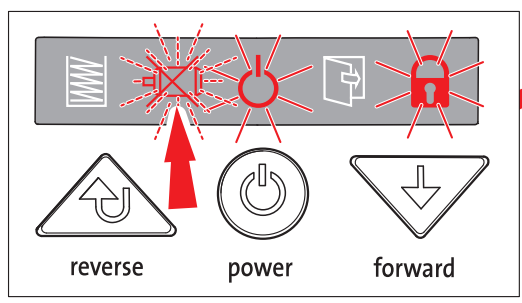

3.11

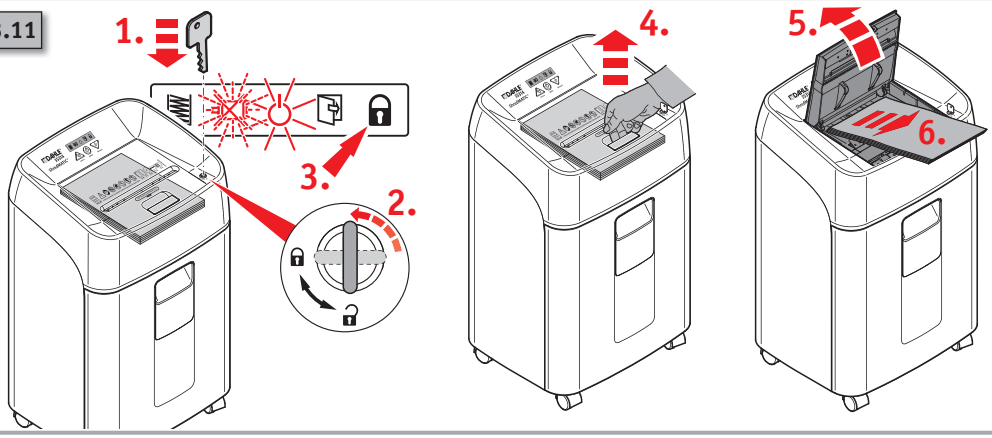

3.12

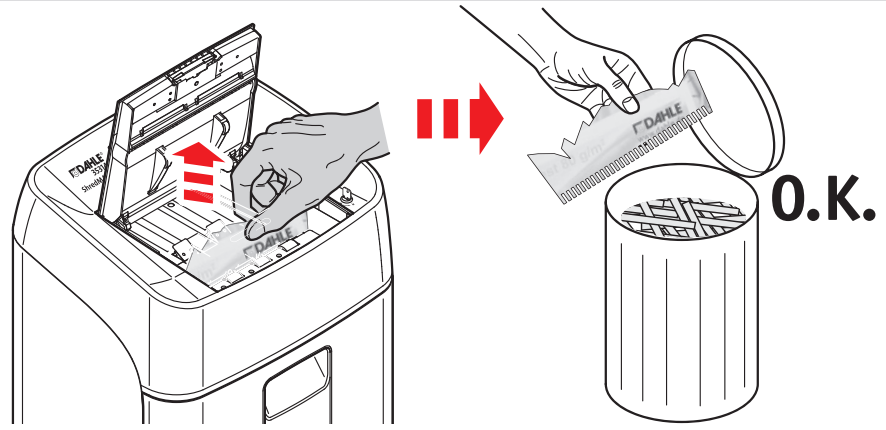

2



3.13

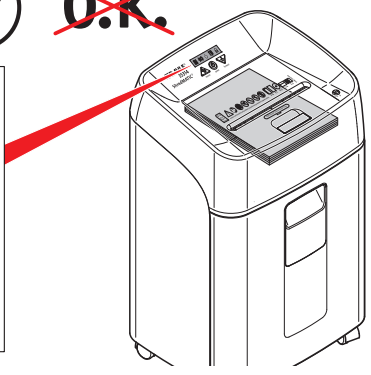
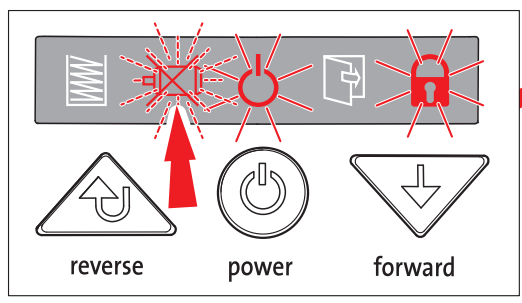

3.14

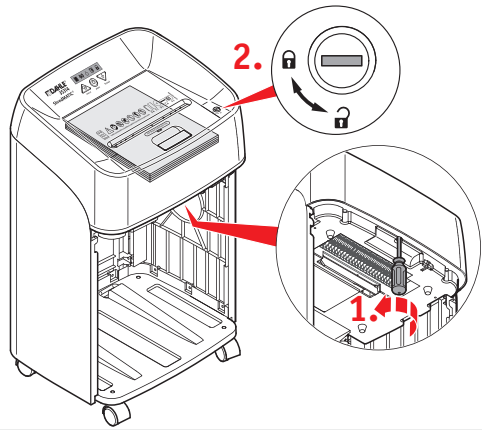
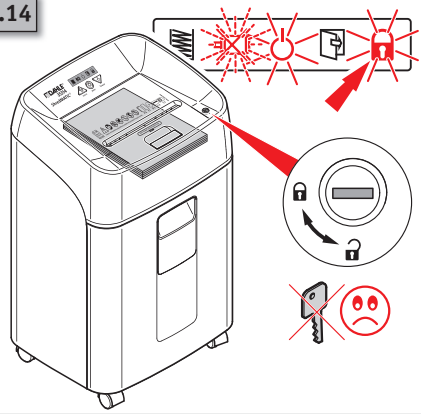

3.15

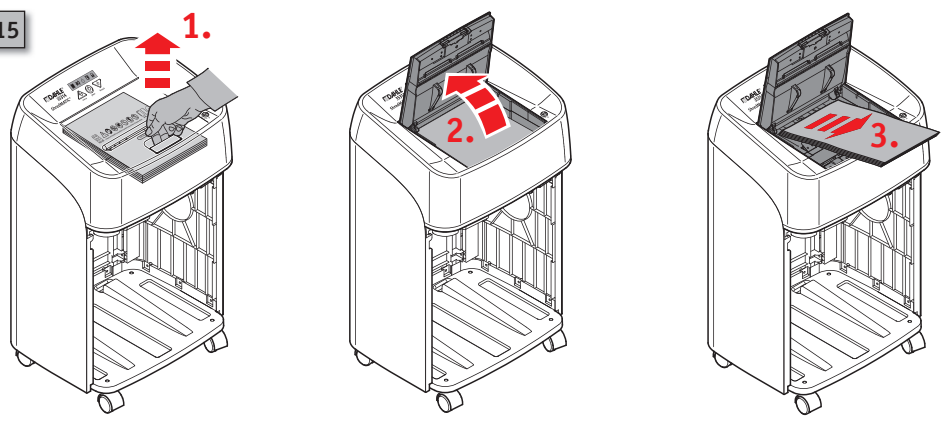



3.16

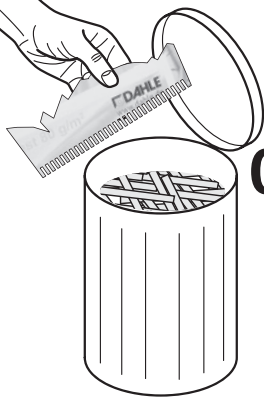
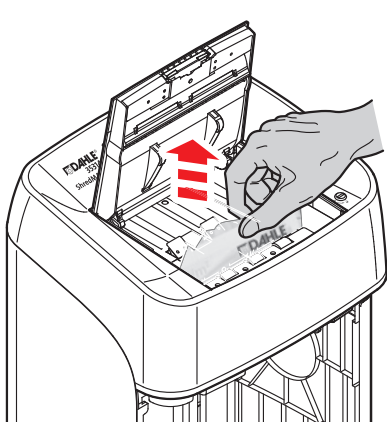

3.17

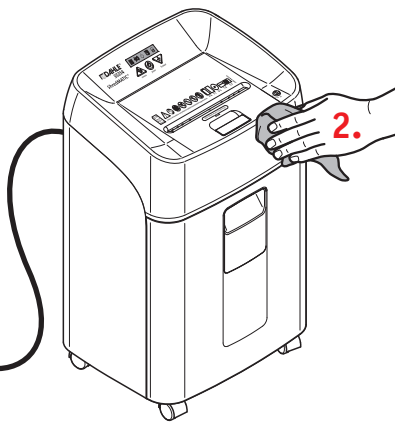

3.18

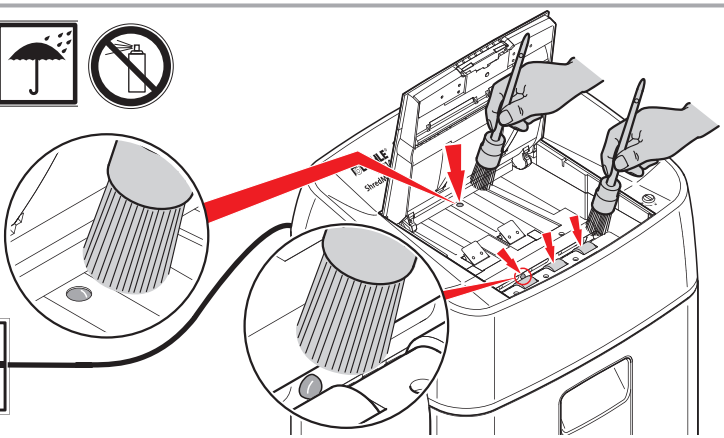

Headquarters:

Novus Dahle GmbH
Breslauer Straße 34-38
49808 Lingen (Ems) / Germany

Service contact:

Novus Dahle GmbH
Nikolaus-A.-Otto-Straße 11
96472 Rödental / Germany
Tel.: +49 (0) 9563 75299-0
Fax: +49 (0) 9563 75299-333
E-Mail: info@novus-dahle.com
Web: www.novus-dahle.com